

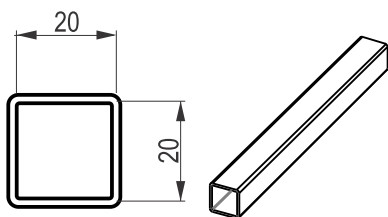

MODULARNI SISTEM ZA OTVORENE POLICE - QUADRO PREMIUM NOVI

* **Pojednostavljena verzija** - lakša za montažu. Profili se buše po sredini.





QP 2719



		šifra
4	mat crna	6479
Jedinica mere: metar		

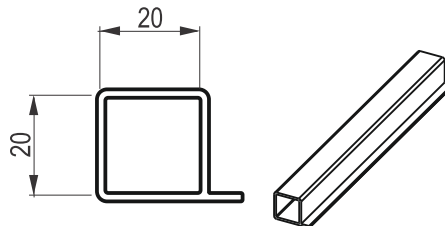

QP 2721



		šifra
4	mat crna	4808
Jedinica mere: metar		

QP 2721 guma



		šifra
m	mat crna	4809
Jedinica mere: metar		

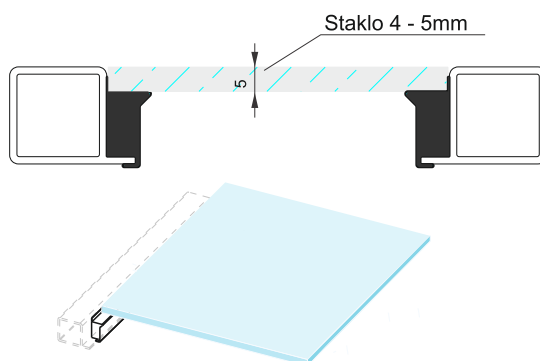

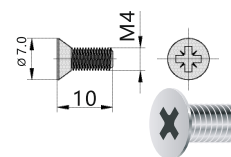

QP šraf M4x10 crna



		šifra
kom	mat crna	10359
Jedinica mere: komad		

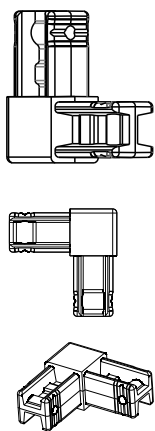

QP metalni ugao 2 kraka

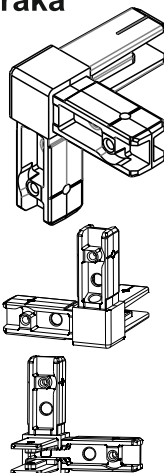

		šifra
kom	mat crna	7827
Jedinica mere: komad		

QP metalni ugao 3 kraka



		šifra
kom	mat crna	204
Jedinica mere: komad		

QP metalni ugao 4 kraka

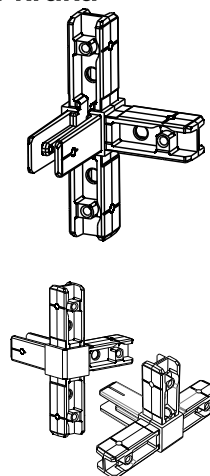

		šifra
kom	mat crna	7121
Jedinica mere: komad		

QP metalni ugao 5 krakova

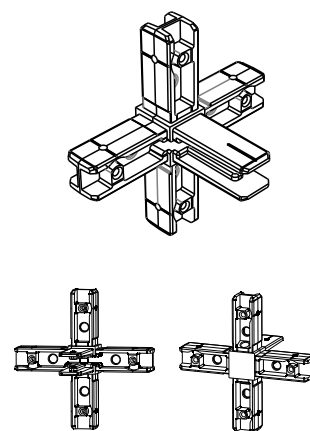

		šifra
kom	mat crna	7120
Jedinica mere: komad		



MODULARNI SISTEM ZA OTVORENE POLICE - QUADRO PREMIUM NOVI

* **Pojednostavljena verzija** - lakša za montažu. Profili se buše po sredini.

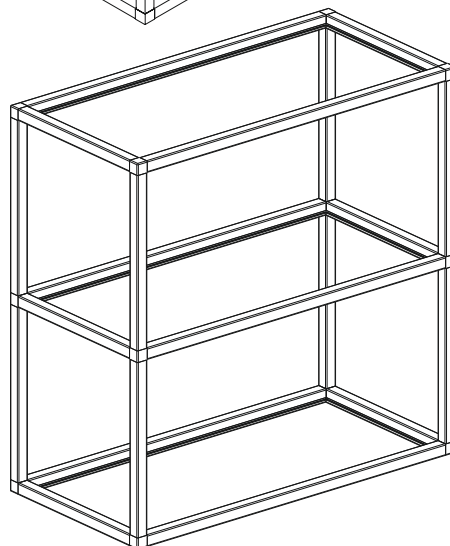
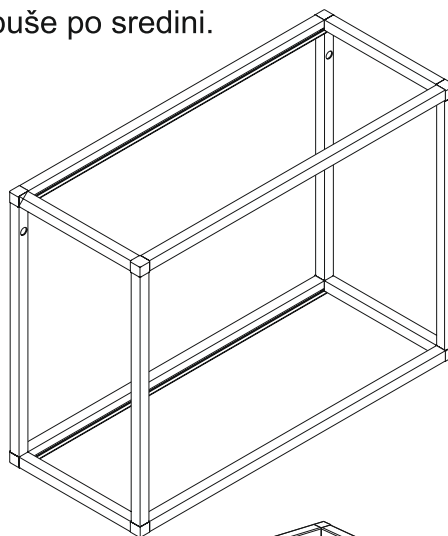
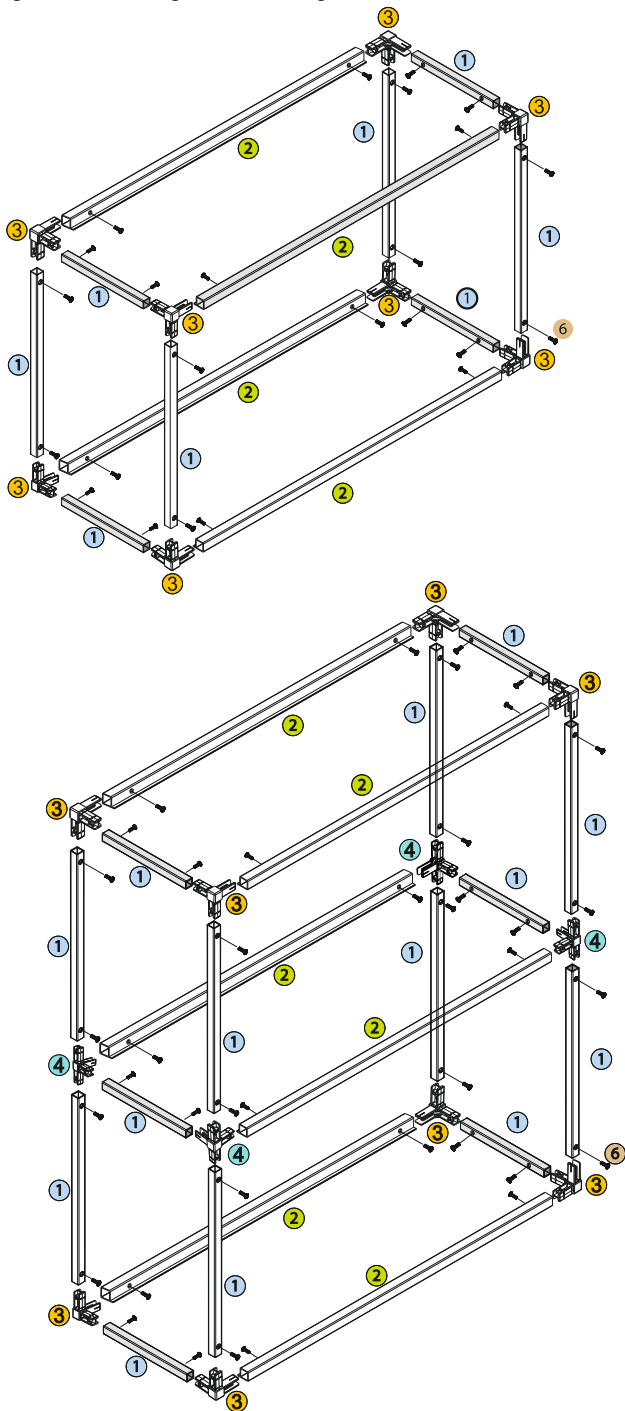

	Šifra:	Naziv proizvoda:
1	6479	QP 2719 kvadro profil al CRNA
2	4808	QP 2721 kvadro profil al CRNA
3	204	QP met. ugao 3 kraka zavr. / N CRNA
4	7121	QP met. ugao 4 kraka zavr. / N CRNA
6	10359	QP šraf M4x10 CRNA



MODULARNI SISTEM ZA OTVORENE POLICE - QUADRO PREMIUM NOVI

* **Pojednostavljena verzija** - lakša za montažu. Profili se buše po sredini.

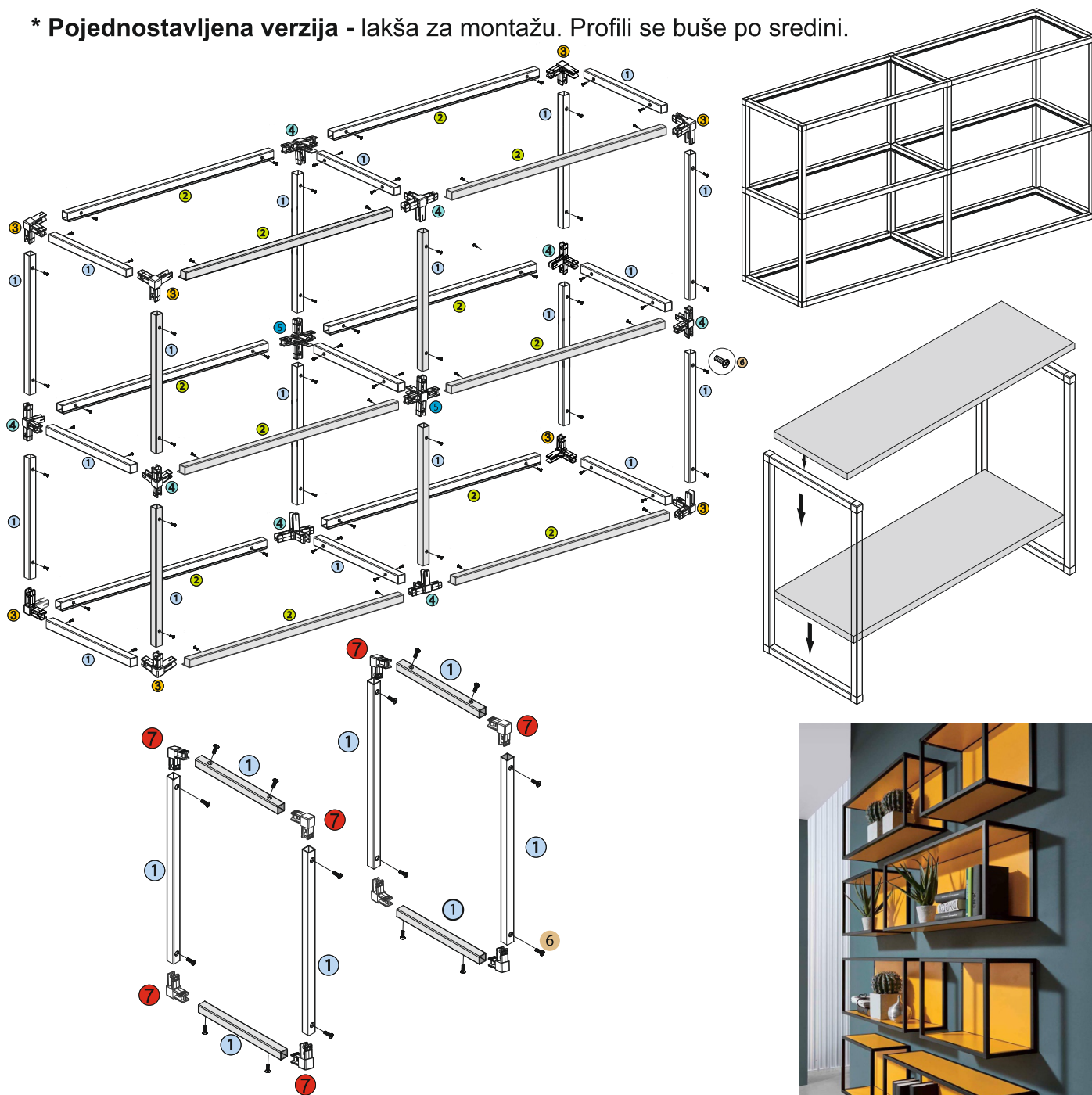

Šifre:		Naziv proizvoda:
1	6479	QP 2719 kvadro profil al CRNA
2	4808	QP 2721 kvadro profil al CRNA
3	204	QP met. ugao 3 kraka zavr. / N CRNA
4	7121	QP met. ugao 4 kraka zavr. / N CRNA
5	7120	QP met. ugao 5 krakova zavr. / N CRNA
6	10359	QP šraf M4x10 CRNA
7	7827	QP met. ugao 2 kraka zavr. / N CRNA



MODULARNI SISTEM ZA OTVORENE POLICE - QUADRO PREMIUM NOVI

* **Pojednostavljena verzija** - lakša za montažu. Profili se buše po sredini.

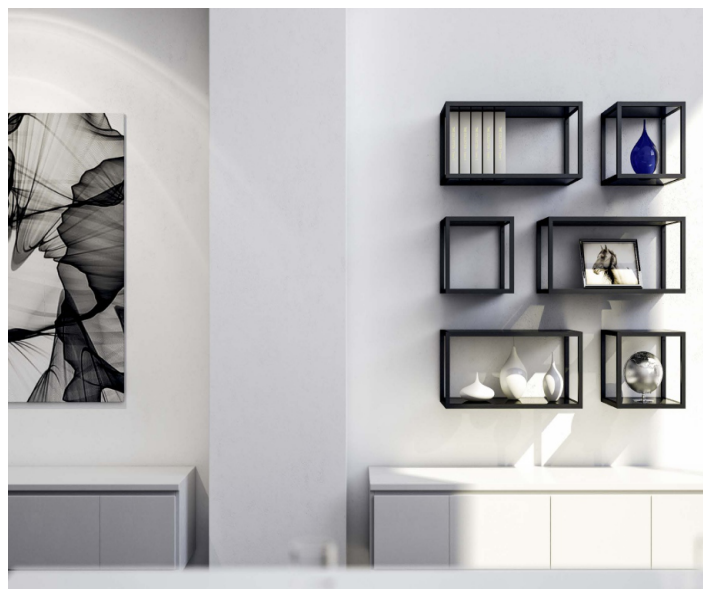

Napomena:



1. Gotove Quadro police po meri isporučujemo sklopljene ili u delovima koji su pripremljeni za sklapanje i montažu.
2. Guma i šrafovi su uključeni u cenu i dolaze zajedno u kompletu sa gotovim Quadro policama.
3. Maksimalna dozvoljena širina Quadro policica je 1200mm bez prekida, maksimalna dubina je 500mm, a visina je ograničena dužinom vertikalnog profila (3m).
4. Moguće je spajanje po visini u više nivoa nego što je prikazano na primeru. Za specifične izgledе policica, molimo Vas da nas kontaktirate na: office@europrofil.rs

MODULARNI SISTEM ZA OTVORENE POLICE - QUADRO



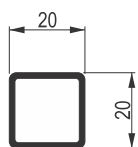



QP 2719

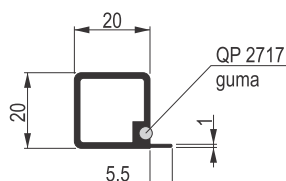

		
4	mat crna	6479
Jedinica mere: metar		

QP 2717



		
4	mat crna	6480
Jedinica mere: metar		

QP 2718

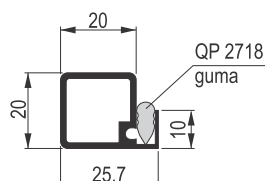

		
4	mat crna	6481
Jedinica mere: metar		

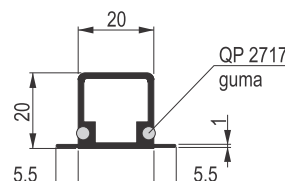

QP 2720



		
4	mat crna	6910
Jedinica mere: metar		

QP 2717 guma





		
m	mat crna	6485
Jedinica mere: metar		

Guma QP 2717, upotrebljavaju se kada je potrebno napraviti police od drveta debljine 18mm.

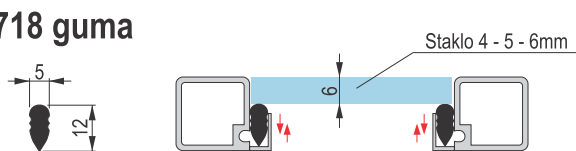
QP 2718 guma





		
m	mat crna	6484
Jedinica mere: metar		

Guma QP 2718 može da se podiže ili spušta, u zavisnosti od debljine stakla. Quadro staklene police su predviđene za stakla debljine od 4 do 6mm.

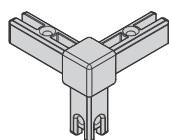

QP Metalni ugao 3 kraka



		
kom	mat crna	6482
Jedinica mere: komad		

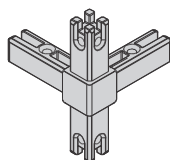

QP Metalni ugao 4 kraka - vezni



		
kom	mat crna	6483
Jedinica mere: komad		

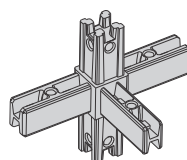

QP Metalni ugao 5 krakova



		
kom	mat crna	6911
Jedinica mere: komad		

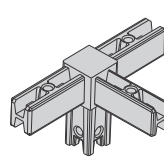

QP Metalni ugao 4 kraka - završni



		
kom	mat crna	6912
Jedinica mere: komad		

QP Metalni šraf M5 x 12mm



		
kom	mat crna	6486
Jedinica mere: komad		

QP Metalni uglovi imaju urezane navoje sa gornje i sa donje strane, što omogućava spajanje sa profilima tako da se šrafovi ne vide nakon montaže.

Profili za izradu policica, izlaganje robe i kačenje žičanih elemenata



* Sve dužine su u metrima, ukoliko drugačije nije naznačeno.

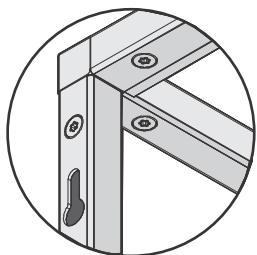

Otvori za zidno kačenje pripremaju se na zahtev!

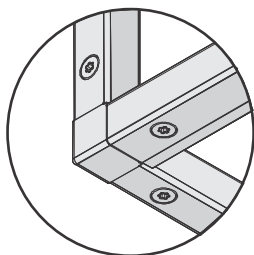

Zahvaljujući uglovima koji imaju urezan navoj sa obe strane, šrafove je moguće postaviti sa gornje ili sa donje strane Al profila. Ova opcija omogućava sakrivanje šrafova u odnosu na poziciju police u prostoru.



QP QUADRO - STANDARD

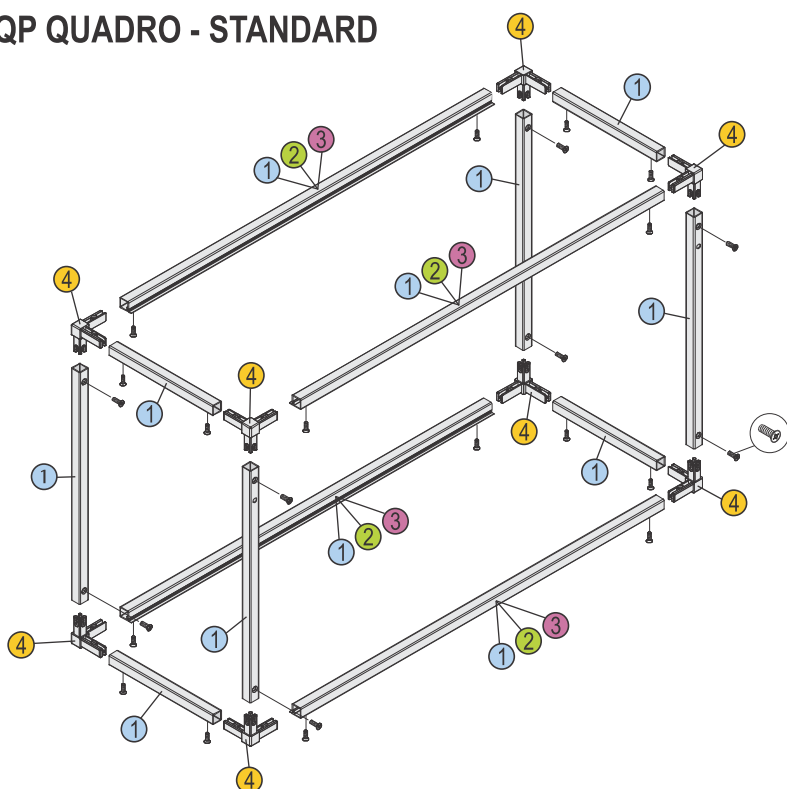

QP 2719

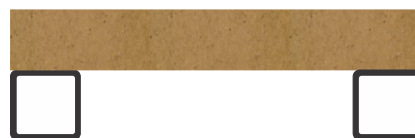

Koristi se uglavnom kao vertikalni profil, a po potrebi može se koristiti i kao horizontalni profil.

QP 2717

QP 2717 guma



Koristi se kao horizontalni profil namenjen za izradu drvenih policica debljine 18mm.

Guma QP 2717 - služi da odvoji drvenu ispunu od Al profila.

QP 2718

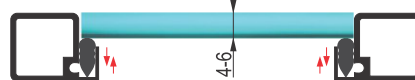

Koristi se kao horizontalni profil namenjen za izradu staklenih policica debljine od 4 do 6mm.

Guma QP 2718 - može da se podiže ili spušta, u zavisnosti od debljine stakla.

QP Metalni ugao 3 kraka

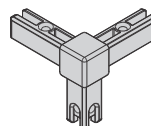

	Šifra	Naziv proizvoda
1	6479	QP 2719
2	6480	QP 2717
3	6481	QP 2718
4	6482	QP Metalni ugao tri kraka

Napomena:

1. Gotove Quadro police po meri isporučujemo sklopljene ili u delovima koji su pripremljeni za sklapanje i montažu.
2. Guma i šrafovi su uključeni u cenu i dolaze zajedno u kompletu sa gotovim Quadro policama.
3. Maksimalna dozvoljena širina Quadro policica je 1200mm bez preklopa, maksimalna dubina je 500mm, a visina je ograničena dužinom vertikalnog profila (3m).
4. Za specifične izgleda policica, molimo Vas da nas kontaktirate na: office@europrofil.rs

Profili za izradu policama, izlaganje robe i kačenje žičanih elemenata



* Sve dužine su u metrima, ukoliko drugačije nije naznačeno.

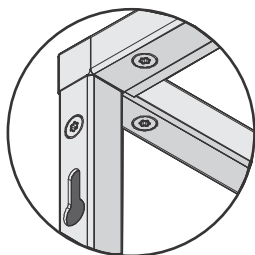

Otvori za zidno kačenje pripremaju se na zahtev!

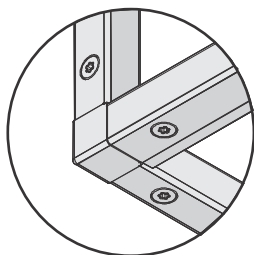

Zahvaljujući uglovima koji imaju urezan navoj sa obe strane, šrafove je moguće postaviti sa gornje ili sa donje strane Al profila. Ova opcija omogućava sakrivanje šrafova u odnosu na poziciju policu u prostoru.



QP QUADRO - NA SPRAT

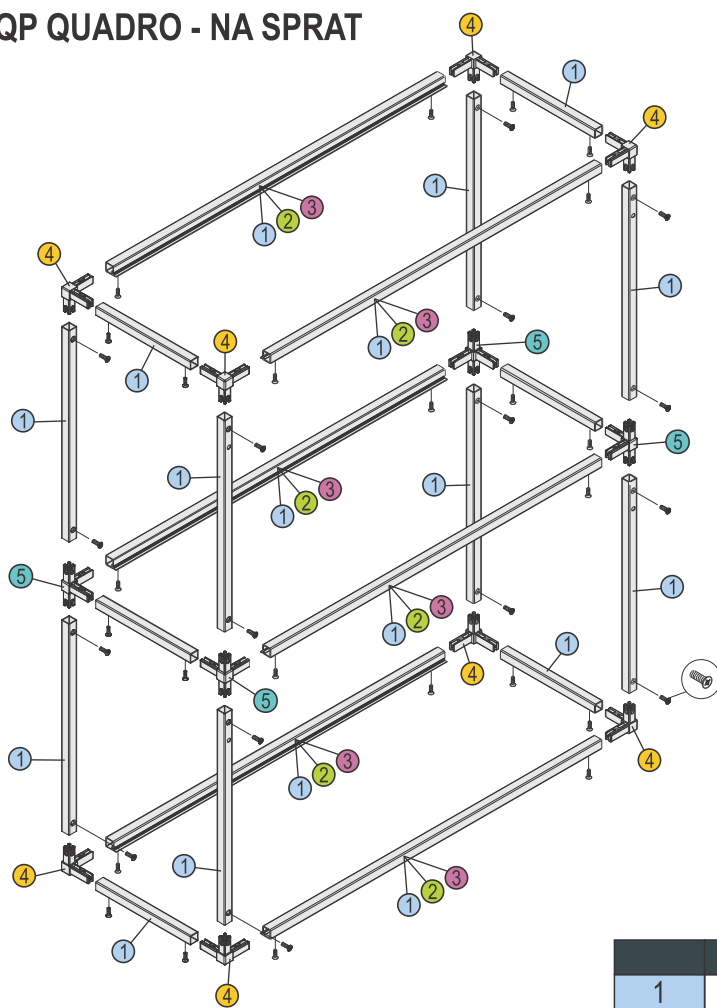

QP 2719

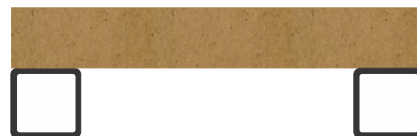

Koristi se uglavnom kao vertikalni profil, a po potrebi može se koristiti i kao horizontalni profil.

QP 2717

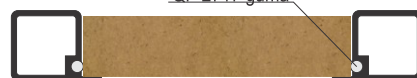

Koristi se kao horizontalni profil namenjen za izradu drvenih policama debljine 18mm.

Guma QP 2717 - služi da odvoji drvenu ispunu od Al profila.

QP 2718

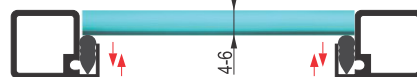

Koristi se kao horizontalni profil namenjen za izradu staklenih policama debljine od 4 do 6mm.

Guma QP 2718 - može da se podiže ili spušta, u zavisnosti od debljine stakla.

QP Metalni ugao 3 kraka

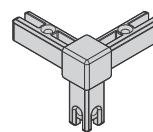

QP Metalni ugao 4 kraka - vezni

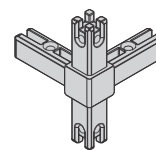

	Šifra	Naziv proizvoda
1	6479	QP 2719
2	6480	QP 2717
3	6481	QP 2718
4	6482	QP Metalni ugao tri kraka
5	6483	QP Metalni ugao četiri kraka - vezni

Napomena:

1. Gotove Quadro police po meri isporučujemo sklopljene ili u delovima koji su pripremljeni za sklapanje i montažu.
2. Guma i šrafovi su uključeni u cenu i dolaze zajedno u kompletu sa gotovim Quadro policama.
3. Maksimalna dozvoljena širina Quadro policama je 1200mm bez prekida, maksimalna dubina je 500mm, a visina je ograničena dužinom vertikalnog profila (3m).
4. Moguće je spajanje po visini u više nivoa nego što je prikazano na primeru. Za specifične izgleda policama, molimo Vas da nas kontaktirate na: office@europrofil.rs

Profili za izradu policica, izlaganje robe i kačenje žičanih elemenata

* Sve dužine su u metrima, ukoliko drugačije nije naznačeno.

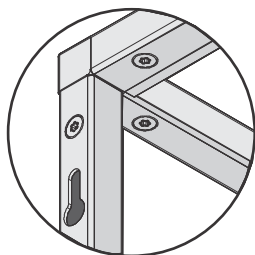

Otvori za zidno kačenje pripremaju se na zahtev! Zahvaljujući uglovima koji imaju urezan navoj sa obe strane, šrafove je moguće postaviti sa gornje ili sa donje strane Al profila. Ova opcija omogućava sakrivanje šrafova u odnosu na poziciju police u prostoru.



QP QUADRO - SPOJENE POLICE

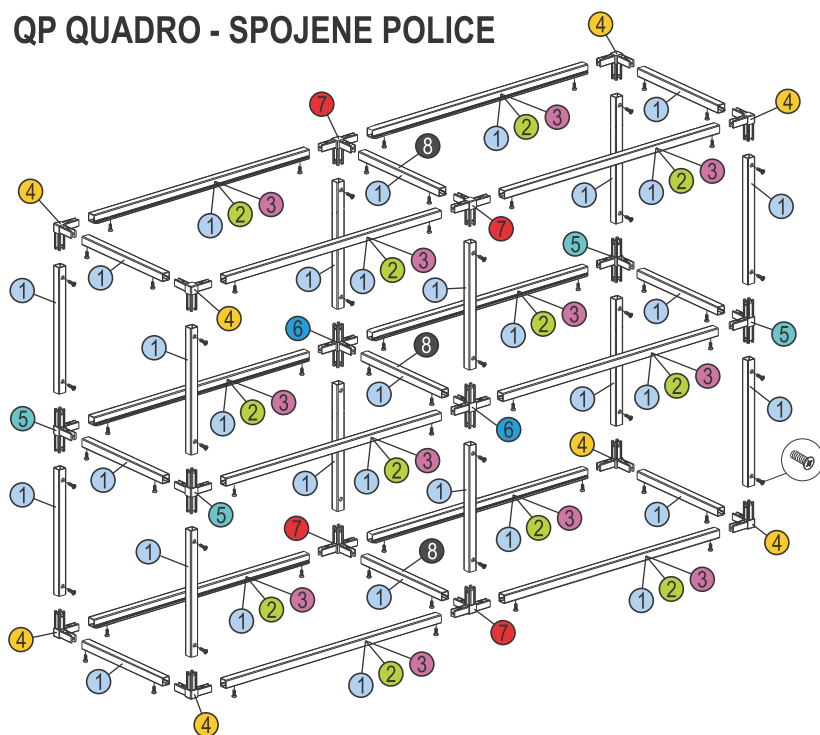

Koristi se kao horizontalni profil namenjen za izradu drvenih policica debljine 18mm. Najčešće se postavlja između dve police, prilikom spajanja policica.

	Šifra	Naziv proizvoda
1	6479	QP 2719
2	6480	QP 2717
3	6481	QP 2718
4	6482	QP Metalni ugao 3 kraka
5	6483	QP Metalni ugao 4 kraka - vezni
6	6911	QP Metalni ugao 5 krakova
7	6912	QP Metalni ugao 4 kraka - završni
8	6910	QP 2720

Napomena:

1. Gotove Quadro police po meri isporučujemo sklopljene ili u delovima koji su pripremljeni za sklapanje i montažu.
2. Guma i šrafovi su uključeni u cenu i dolaze zajedno u kompletu sa gotovim Quadro policama.
3. Maksimalna dozvoljena širina Quadro policica je 1200mm bez prekida, maksimalna dubina je 500mm, a visina je ograničena dužinom vertikalnog profila (3m).
4. Moguće je spajanje po visini i širini u više nivoa nego što je prikazano na primeru. Za specifične izgleda policica, molimo Vas da nas kontaktirate na: office@europrofil.rs

QP 2719

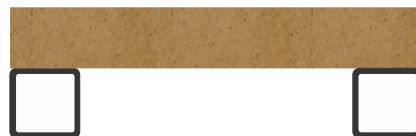

Koristi se uglavnom kao vertikalni profil, a po potrebi može se koristiti i kao horizontalni profil.

QP 2717

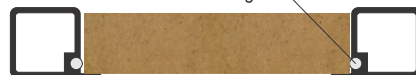

Koristi se kao horizontalni profil namenjen za izradu drvenih policica debljine 18mm.

Guma QP 2717 - služi da odvoji drvenu ispunu od Al profila.

QP 2718

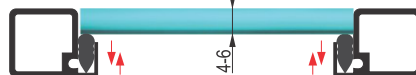

Koristi se kao horizontalni profil namenjen za izradu staklenih policica debljine od 4 do 6mm.

Guma QP 2718 - može da se podiže ili spušta, u zavisnosti od debljine stakla.

QP Metalni ugao 3 kraka

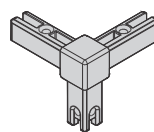

QP Metalni ugao 4 kraka - vezni

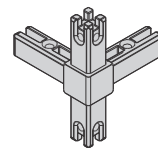

QP Metalni ugao 5 krakova

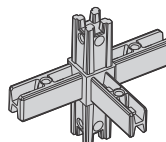

QP Metalni ugao 4 kraka - završni

