

PV OP 03 sistem za izradu drvenih plakarskih vrata

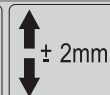

PV OP 03 mehanizam sa polugom

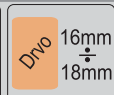
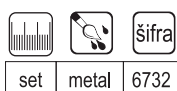

Tehnički crteži i prikaz montaže mehanizma

Podešavajuća poluga za PV OP mehanizam

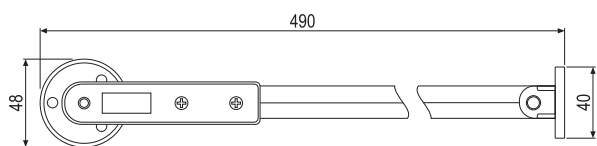

Šablon za montažu međušarki

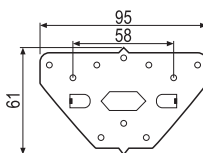

Međušarka za PV OP mehanizam

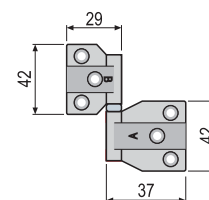

Prikaz PV OP mehanizma sa jednim vratima (2 krila)

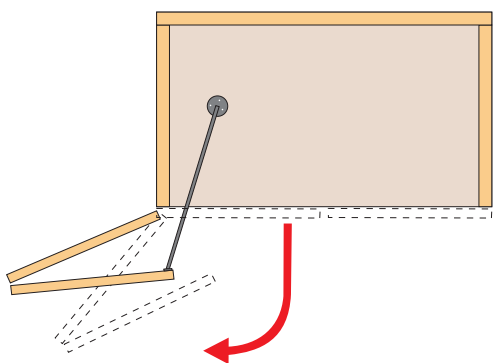

Prikaz PV OP mehanizma sa dvoje vrata (4 krila)

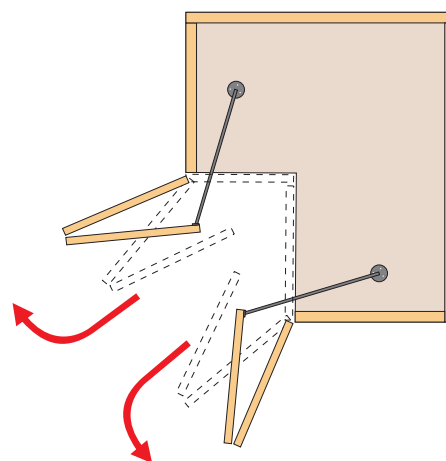

Prikaz PV OP mehanizma sa dvoje vrata (4 krila)

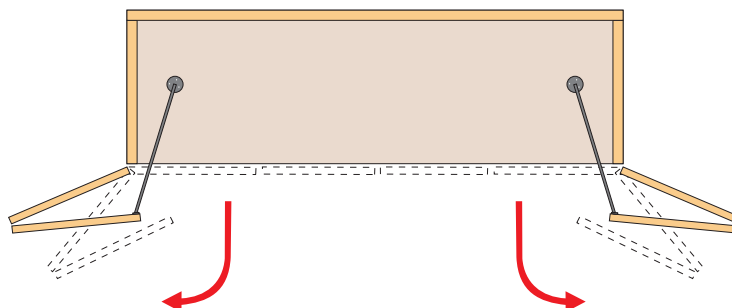

40kg	Dvo 16mm / 18mm	± 2mm	Meko zatvaranje
------	-----------------	-------	-----------------

Tehnički crteži i prikaz montaže mehanizma

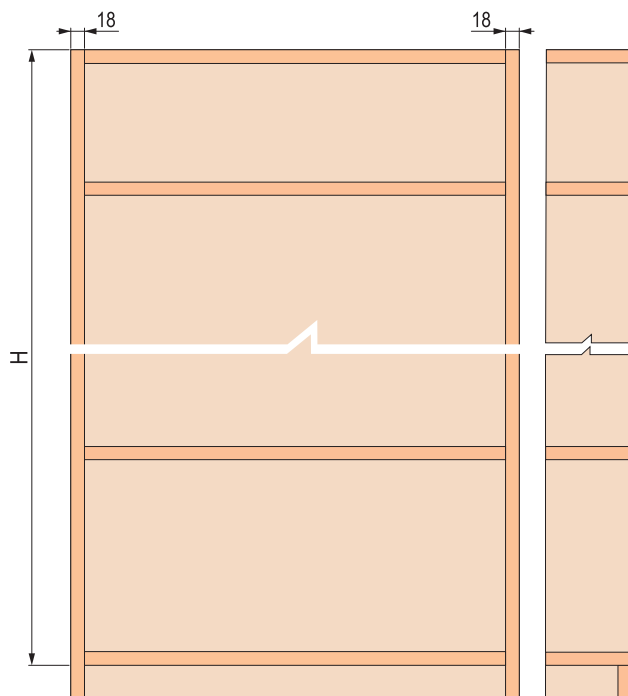
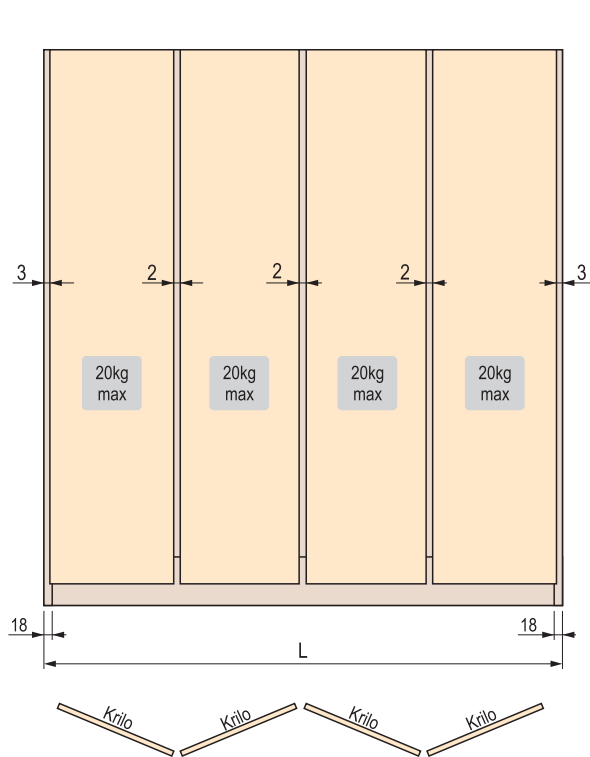

Širina kriila = $\frac{L - 3 \times 2 - 2 \times 3}{\text{broj kriila}}$

Širina kriila može biti od: 300 do 400mm.

Visina kriila je proizvoljna, dokle god ne prelazi maksimalnu težinu od 20kg!

Dimenzije za pripremu ispune (vrata) za montažu

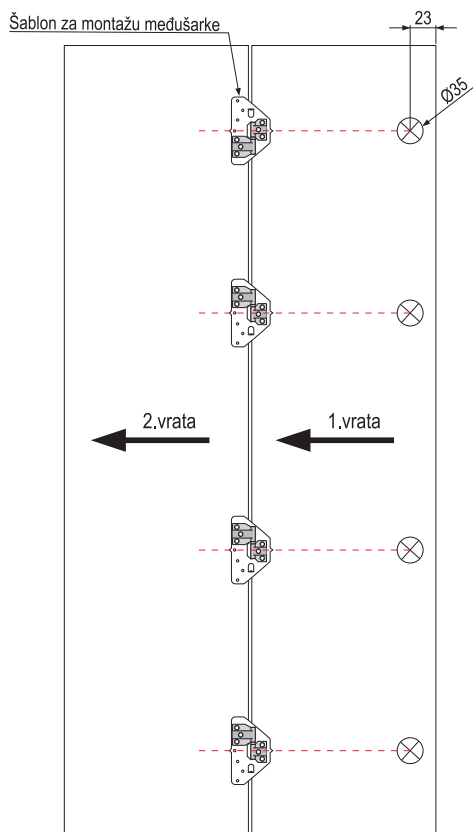

Pozicija poluge na korpusu se određuje označavanjem preseka dveju putanja po kojim se kreće poluga kada se vrata otvaraju i zatvaraju.

