

europrofil

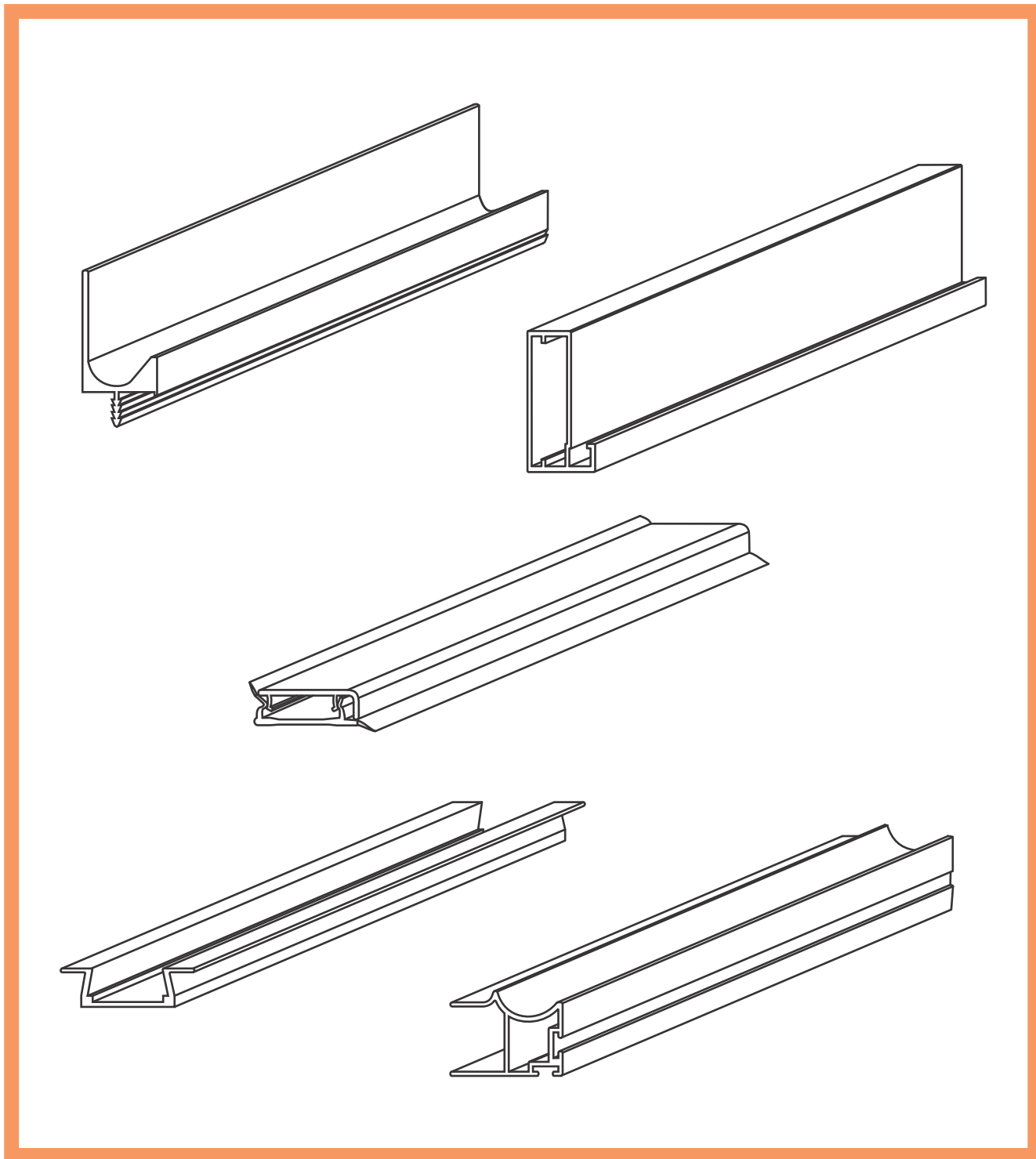

**Profili za izradu nameštaja
od pločastih materijala**

2019

Poštovani,

U narednim stranicama videćete našu ponudu profila i elemenata za izradu nameštaja.

Trudili smo se da u našem poslovanju uvek ponudimo što kvalitetnije proizvode sa jasnim objašnjenjem za koju su primenu namenjeni.

Na prvom mestu uvek su nam bili funkcionalnost i izgled proizvoda koji mora da prati savremene trendove u izradi nameštaja.

U novom katalogu možete videti našu ponudu profila i gotovih proizvoda, a na našem sajtu **www.europrofil.rs**, uvek možete videti najnovije proizvode iz naše ponude.

Poverenje koje ste nam ukazali u proteklih petnaest godina, znak je da smo na pravom putu, a želja nam je da i dalje rastemo zajedno sa Vama.

europrofil



Sadržaj kataloga

RU Aluminijumski rukohvati, ugradne i nadgradne ručice i četkice za rukohvate	2
VP Vezni i pregradni profili i FLAH dekorativni profili	12
LED Aluminijumski profili za izradu nameštaja	16
KP Aluminijumski kant i pult profili	22
QP, ONP i PANO Sistemi profila za izradu polica	27
CN Aluminijumske i PVC cokle za izradu nameštaja	34
VEN Aluminijumske i PVC ventilacione rešetke za vrata i pločasti materijal	39
DP Aluminijumski i PVC diht profili za radne ploče	44
T Vezni profili za radne ploče	50
UP Aluminijumske i metalne garderobne šipke - oklagije i prateći elementi	53
RAM Aluminijumski profili i PVC elementi za izradu staklenih frontova	57
TAB Aluminijumski profili i PVC elementi za izradu tabli	65
REK Aluminijumski profili i elementi za izradu reklama	67
Aluminijumske protivklizne i perforirane table	76

ALUMINIJUMSKI RUKOHVATI I RUČICE

- UKRUTNI PROFILI I RUKOHVATI
- PRATEĆI PRIBOR - ČETKICE ZA RUKOHVATE
- UKOPAVAJUĆI RUKOHVATI I RUČICE
- HORIZONTALNE I VERTIKALNE SKRIVENE RUČICE

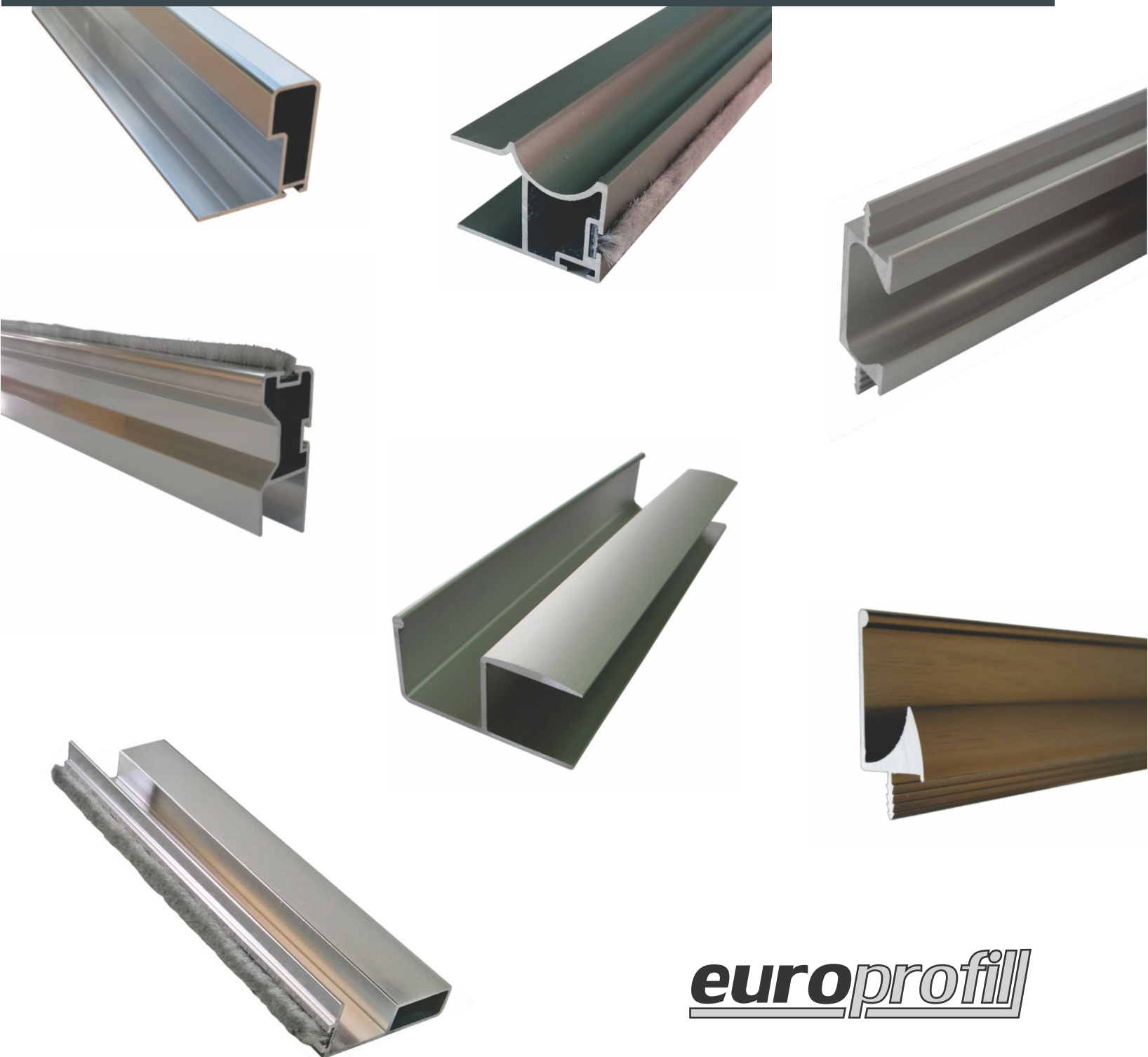

europofil



Jedinica mere: metar

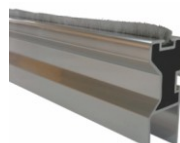
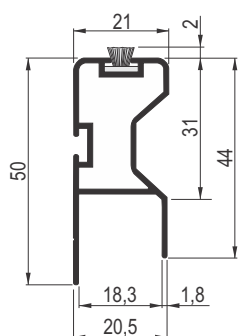

RU 75 - F AL UKRUTNI RUKOHVAT

Dekoratívni rukohvat **sa četkicom** za pločaste materijale debljine 18mm. Al rukohvati su hemijski eloksirani.



2,7	mat srebro	880	2,7	mat bronza	4289
6	mat srebro	5210	6	mat bronza	2345
2,7	sjaj srebro	4713			

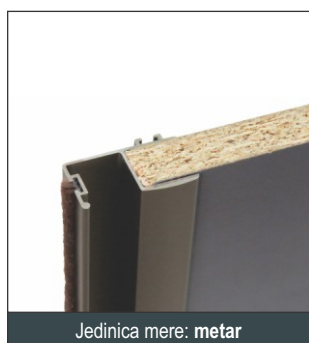

Jedinica mere: metar

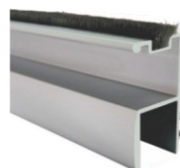
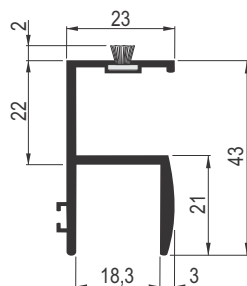

RU 39 AL UKRUTNI RUKOHVAT

Dekoratívni rukohvat **sa četkicom** za pločaste materijale debljine 18mm. Al rukohvati su hemijski eloksirani.



2,7	mat srebro	358	2,7	sjaj srebro	4508	2,7	mat bronza	2727
6	mat srebro	5208	5,5	sjaj srebro	1866	6,2	mat bronza	1587



Jedinica mere: metar

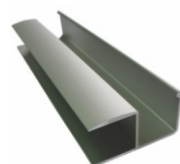
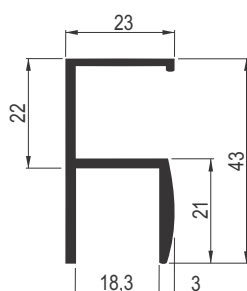

RU 39 / S AL UKRUTNI RUKOHVAT

Dekoratívni rukohvat **bez četkice** za pločaste materijale debljine 18mm. Al rukohvati su hemijski eloksirani. Mogu se koristiti PVC samolepljive četkice.



2,7	mat srebro	608	2,5	sjaj srebro	877
6	mat srebro	5214			

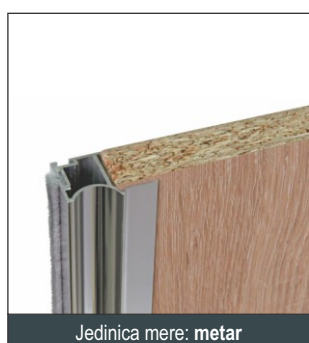

Jedinica mere: metar

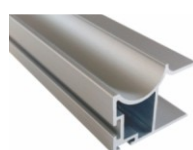
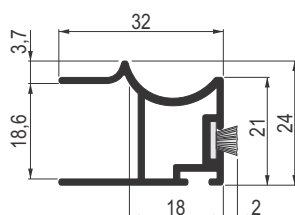

RU 70 AL UKRUTNI RUKOHVAT

Dekoratívni rukohvat **sa četkicom** za pločaste materijale 18mm. Al rukohvati su hemijski eloksirani.



2,7	mat srebro	4373	6,2	mat srebro	41
2,7	sjaj srebro	2066	2,7	mat bronza	2069





Jedinica mere: metar

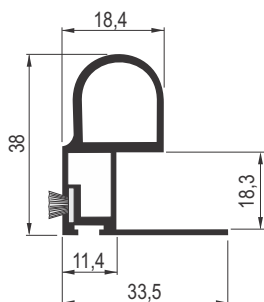

RU 38
AL UKRUTNI RUKOHSVAT

Dekoratívni rukohvat **sa četkicom** za pločaste materijale 18mm debljine. Al rukohvati su hemijski eloksirani.



2,7	mat srebro	190
-----	------------	-----

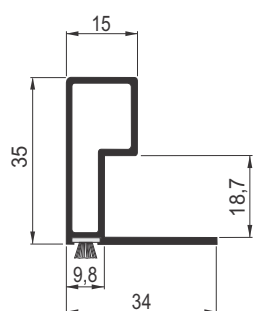

RU 321 AL RUKOHSVAT

Dekoratívni rukohvat **sa četkicom** za pločaste materijale 18mm debljine.



2,7	mat srebro	261
6	mat srebro	5278
2,7	sjaj srebro	2524

Jedinica mere: metar

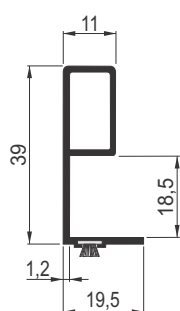

RU 355 AL RUKOHSVAT

Dekoratívni rukohvat **sa četkicom** za pločaste materijale 18mm debljine. Al rukohvati su hemijski eloksirani.



2,7	mat srebro	6904
2,7	sjaj srebro	6905

Jedinica mere: metar



Jedinica mere: komad / metar

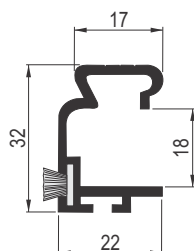

RU 49
AL RUKOHSVAT

Dekoratívni rukohvat **sa četkicom** za pločaste materijale 18mm debljine. Al rukohvati su hemijski eloksirani.



2,7	mat srebro	187	6	mat srebro	329
2,7	mat zlato	186	Jedinica mere: metar		
2,7	sjaj srebro	182			

Jedinica mere: komad



Jedinica mere: metar

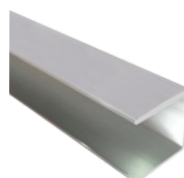
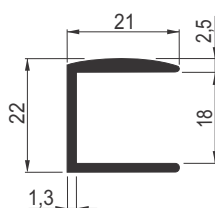

KP 35
AL UKRUTNI PROFIL

Dekoratívni profil za ukrućivanje pločastih materijala debljine 18mm. Al rukohvati su hemijski eloksirani.



2,7	mat srebro	167	2,7	sjaj srebro	4516
6	mat srebro	5209	2,7	mat bronza	4517





Jedinica mere: metar

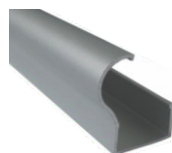
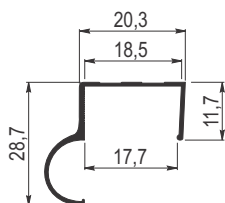

RU 50
AL RUKOHVAT

Dekoratívni profil - rukohvat za pločaste materijale 18mm debljine. Al rukohvati su hemijski eloksirani.



2,7	mat srebro	1808
5,6	mat srebro	5213

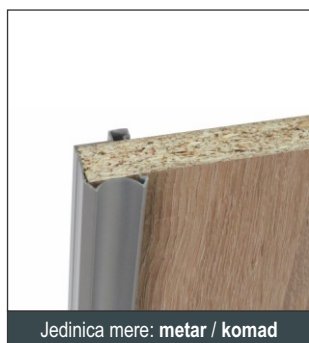

Jedinica mere: metar / komad

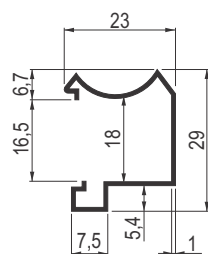

RU 16
DVOSTRANI AL RUKOHVAT

Dekoratívni profil - rukohvat za pločaste materijale 18mm debljine. Al rukohvati su hemijski eloksirani.



2,7	mat srebro	5704	6	mat srebro	5705
Jedinica mere: komad			Jedinica mere: metar		

Prateći pribor - Četkice

Četkice za aluminijumske rukohvate - Samolepljive i na uvlačenje

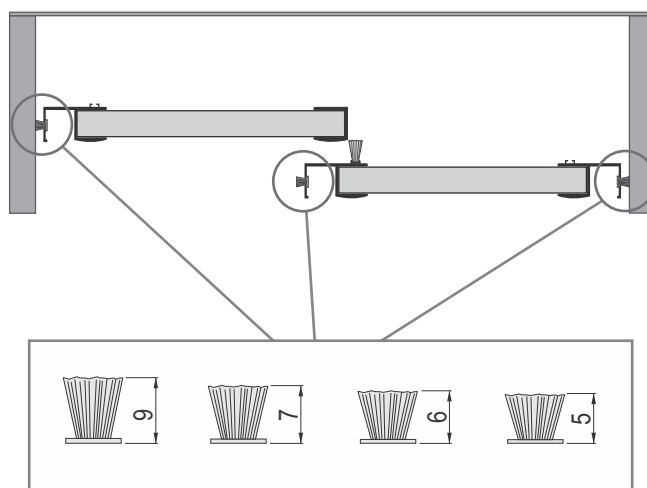
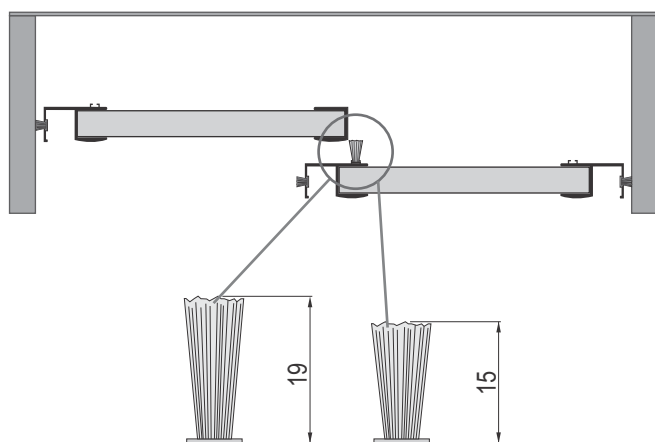

 * Sve dužine su u metrima, ukoliko drugačije nije naznačeno.

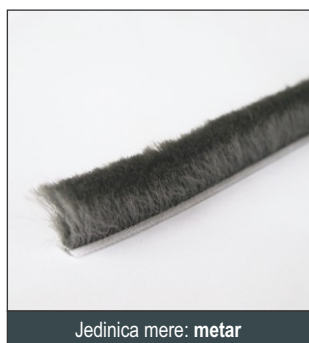



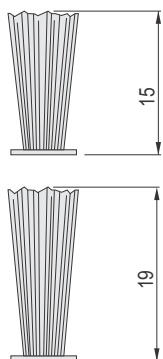

Jedinica mere: metar



EP ČETKICA 15mm i 19mm SAMOLEPLJIVA I NA UVLAČENJE

Četkica 15mm i 19mm koristi se za popunu razmaka između kliznih vrata u svrhu sprečavanja prodiranja prašine unutar korpusa.

				šifra	H					šifra	H
m	siva samolepljiva	2778	15mm		m	siva samolepljiva	2779	19mm			
m	siva uvlačenje	2774		m	siva uvlačenje	2775					

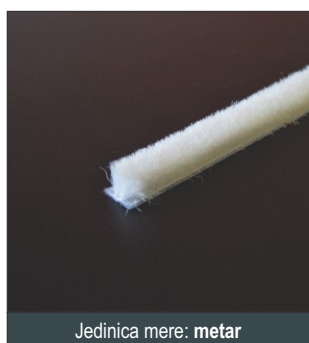

Jedinica mere: metar

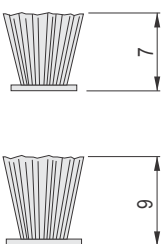

EP ČETKICA 7mm i 9mm SAMOLEPLJIVA I NA UVLAČENJE

Četkica 7mm i 9mm koristi se za popunu razmaka između rukohvata i bočne stranice korpusa, u svrhu sprečavanja prodiranja prašine i amortizacije udaraca. Četkica 9mm dostupna je samo u sivoj boji.

				šifra	H					šifra	H
m	siva samolepljiva	2777	7mm		m	siva uvlačenje	2772	9mm			
m	bela samolepljiva	2780		m	bela uvlačenje	2776					
					m	siva uvlačenje	6730				

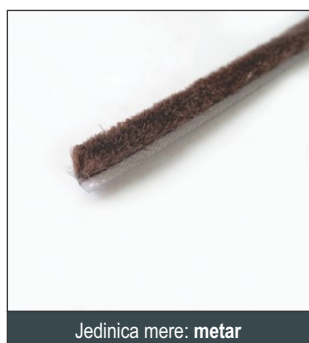



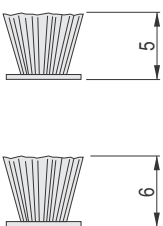

Jedinica mere: metar



EP ČETKICA 5mm i 6mm SAMOLEPLJIVA I NA UVLAČENJE

Četkica 5mm i 6mm koriste se za popunu razmaka između rukohvata i bočne stranice korpusa, u svrhu sprečavanja prodiranja prašine i amortizacije udaraca.

				šifra	H					šifra	H
m	siva samolepljiva	6087	5mm		m	siva uvlačenje	6086	6mm			
m	braon samolepljiva	6070		m	braon uvlačenje	6068					
m	crna samolepljiva	6071		m	crna uvlačenje	6069					



Jedinica mere: komad

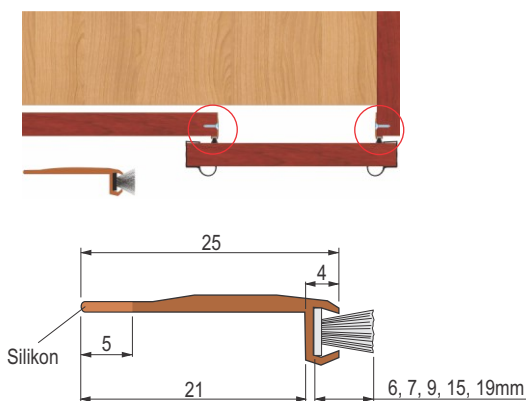

F03 - 1000 PVC PROFIL SA ČETKICOM

Koristi se da popuni razmak između dvoje kliznih vrata, ili razmak između Al rukohvata i bočne stranice korpusa, u svrhu sprečavanja prodiranja prašine. Mogućnost postavljanja četkice na uvlačenje visine 6, 15 i 19mm.

		šifra
2,7	braon	276

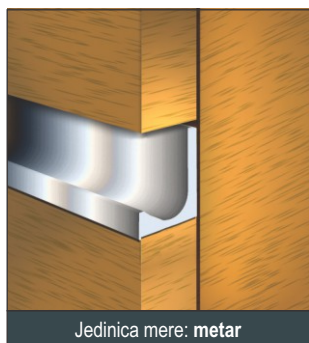

Jedinica mere: metar

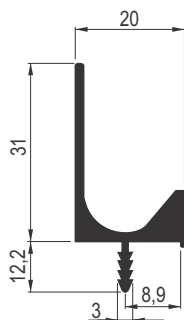

RU U 1013 CM
UKOPAVAJUĆI RUKOHVAT

Al dekorativna ukopavajuća ručica za pločaste materijale debljine 18mm.



3	mat srebro	380
3	brušena bronza	5267
3	sjaj srebro	4788

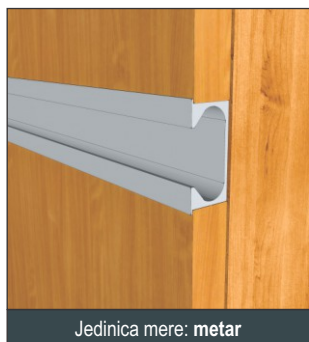

Jedinica mere: metar

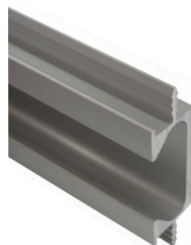
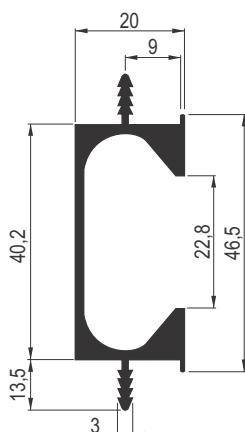

RU U 1013
DVOSTRANI UKOPAVAJUĆI RUKOHVAT

Al dekorativna ukopavajuća ručica za pločaste materijale debljine 18mm.



3	mat srebro	558
---	------------	-----



Jedinica mere: metar

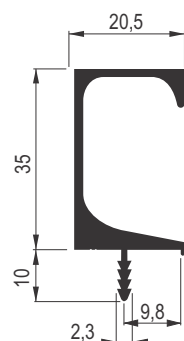

RU U 1013 G
UKOPAVAJUĆI RUKOHVAT

Al dekorativna ukopavajuća ručica za pločaste materijale debljine 18mm.



3	mat srebro	257
3	sjaj srebro	4787
3	brušena bronza	5274

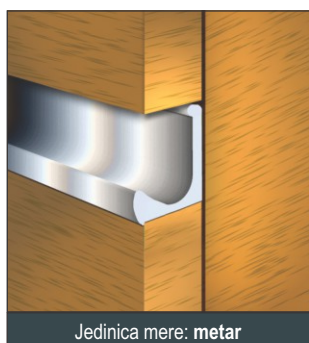

Jedinica mere: metar

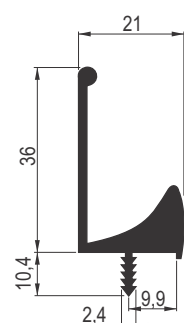

RU U 1013 CZ
UKOPAVAJUĆI RUKOHVAT

Al dekorativna ukopavajuća ručica za pločaste materijale debljine 18mm.



3	mat srebro	560
3	brušena bronza	3145
3	sjaj srebro	4789

RU U 1015
UKOPAVAJUĆA RUČICA

Al profil - ukopavajuća ručica za drvene pločaste materijale debljine 18mm. Ugao 55°.

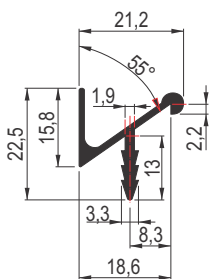

		šifra
3	mat srebro	6916
3	sjaj srebro	6917
3	brušena bronza	6918
Jedinica mere: metar		

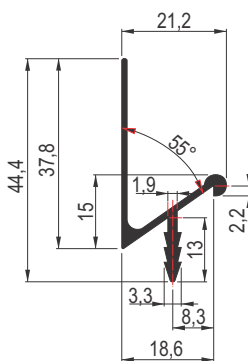

RU U 1017
UKOPAVAJUĆA RUČICA

Al profil - ukopavajuća ručica za drvene pločaste materijale debljine 18mm. Ugao 55°.

		šifra
3	mat srebro	6913
3	sjaj srebro	6914
3	brušena bronza	6915
Jedinica mere: metar		

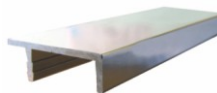
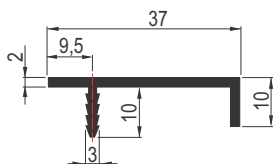
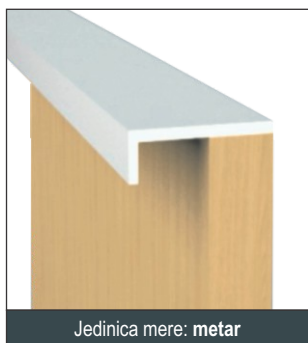

RU U 1012
UKOPAVAJUĆA RUČICA

Al profil - ukopavajuća ručica za drvene pločaste materijale.

		šifra
3	mat srebro	1875
2,5	sjaj srebro	1826

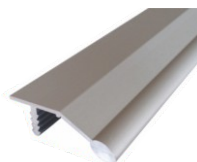
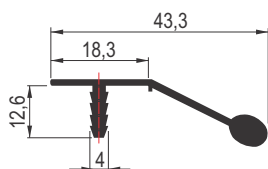

RU U 1013 L
UKOPAVAJUĆA RUČICA

Al profil - ukopavajuća ručica za drvene pločaste materijale debljine 18mm.

		šifra
3	mat srebro	2845

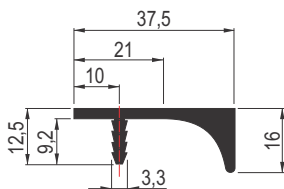

ORN U 217 UKOPAVAJUĆA RUČICA

Ukopavajuća ručica za pločaste materijale u dve završne obrade: srebro mat i srebro sjaj. Ručica ORN U 217 dostupna je u dužinama od 147mm do 797mm.

		šifra			šifra			šifra
347	mat srebro	3768	447	mat srebro	3770	597	mat srebro	3774
347	sjaj srebro	3769	447	sjaj srebro	3771	597	sjaj srebro	3775
147	mat srebro	3766	397	mat srebro	4287	497	mat srebro	3772
147	sjaj srebro	3767	397	sjaj srebro	4288	497	sjaj srebro	3773
						797	mat srebro	3776
						797	sjaj srebro	3777

* Dužine aluminijumskih ukopavajućih ručica ORN U 127 izražene su u milimetrima.

 * Sve dužine su u metrima, ukoliko drugačije nije naznačeno.



Jedinica mere: komad

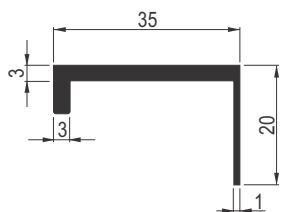

ORN 228

Al profil ručica za pločaste materijale u dve završne obrade: srebro mat i srebro sjaj. Ručica ORN 228 dostupna je u dužinama od 147mm do 797mm.

		šifra			šifra			šifra			šifra
147	mat srebro	6113	397	mat srebro	6115	497	mat srebro	6117	597	mat srebro	6119
147	sjaj srebro	6121	397	sjaj srebro	6123	497	sjaj srebro	6125	597	sjaj srebro	6127
347	mat srebro	6114	447	mat srebro	6116	547	mat srebro	6118	797	mat srebro	6120
347	sjaj srebro	6122	447	sjaj srebro	6124	547	sjaj srebro	6126	797	sjaj srebro	6128

* Dužine aluminijumskih ručica ORN 228 izražene su u milimetrima.



Jedinica mere: metar

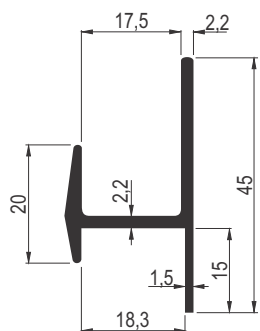

RU U 1013 M

Al dekorativni profil - rukohvat za pločaste materijale debljine 18mm.

		šifra
3	mat srebro	189
3	brušena bronza	3144
3	sjaj srebro	3644





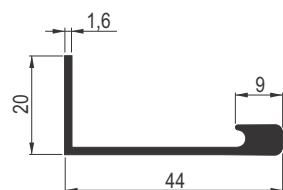

Jedinica mere: metar



RU N 5025

Al profil - ručica za pločaste materijale i aluminijumske frontove. Rukohvat 5025 prodaje se na 1m i 3m.

		šifra			šifra
3	mat srebro	554	3	brušena bronza	3646
3	sjaj srebro	724	3	brušeno sjaj srebro	4778
3	brušeno srebro	3645			



Jedinica mere: metar

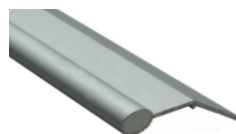
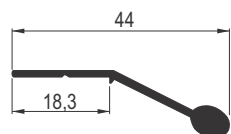

RU N 1013 CS

Al profil - ručica za pločaste materijale debljine 18mm.

		šifra
3	mat srebro	273

* Sve dužine su u metrima, ukoliko drugačije nije naznačeno.



Jedinica mere: metar

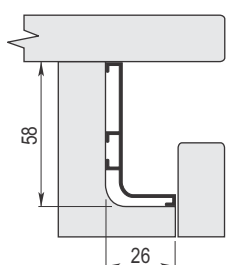

RU U GL - 028
GOLA - HORIZONTALNA RUČICA

Aluminijumska skrivena ručica za izradu nameštaja. Dužina profila je 3m.



3	mat srebro	2764	Al profili	par	srebro	2800	Al čep
3	sjaj srebro	2765		kom	srebro	2799	un.ugao
3	brušena bronza	4286		kom	srebro	2798	sp.ugao
				kom	srebro	2767	L ugao



Jedinica mere: metar

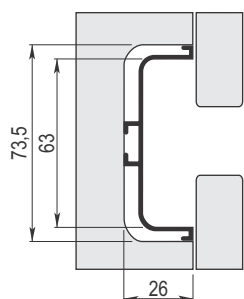

RU U GL - 029
GOLA - HORIZONTALNA RUČICA

Aluminijumska skrivena ručica za izradu nameštaja. Dužina profila je 3m.



3	mat srebro	2762	Al profili	par	srebro	2801	Al čep
3	sjaj srebro	2763		kom	srebro	2767	L ugao
3	brušena bronza	4285					

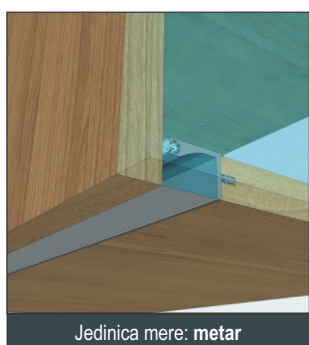

Jedinica mere: metar

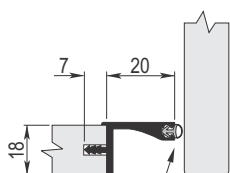

RU U GL - 196
GOLA - HORIZONTALNA RUČICA

Aluminijumska ukopavajuća ručica za izradu nameštaja. Dužina profila je 3m. Uz ovaj profil ide i odgovarajuća GL guma koja se poručuje posebno.



3	mat srebro	2760	Al profil
3	sjaj srebro	2761	Al profil
3	siva	2766	GL guma

GL guma

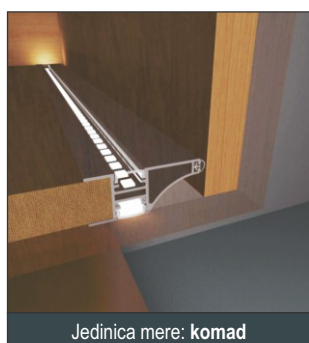

Jedinica mere: komad

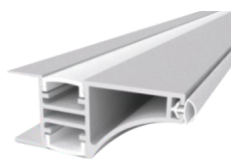
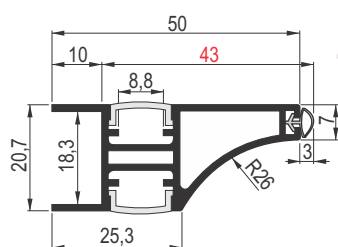

EP - 1069
AI LED PROFIL ZA FRONT

AI LED skriveni rukohvat za izradu fronta. Aluminijumski LED rukohvat omogućava dvostrano postavljanje LED trake. Uz ovaj profil idu i odgovarajući PVC poklopci. LED traka ne dolazi sa AI profilom.



0,99	mat srebro	4138	1,49	mat srebro	535	2,99	mat srebro	4140
------	------------	------	------	------------	-----	------	------------	------

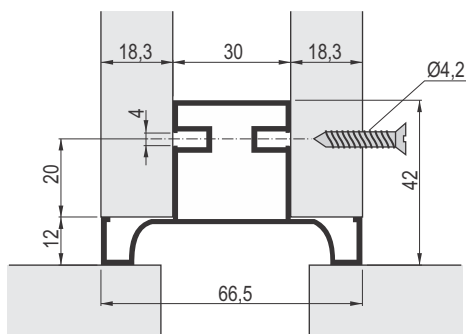
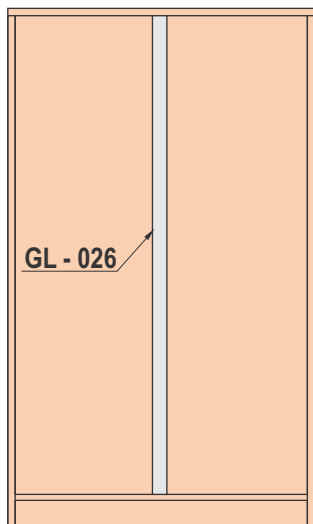

RU U GL - 026
GOLA - VERTIKALNA RUČICA

Aluminijumski profil koristi se kao vertikalna skrivena ručica prilikom izrade nameštaja od pločastog materijala. Uglavnom se postavlja između dve vertikalne stranice. Završna obrada profila dobija se procesom hemijske eloksaže.



	šifra	Prodajne dužine
6 mat srebro	4513	6m, 3m i 2m
5,5 sjaj srebro	4514	5,5m i 2,75m
5,9 brušena bronza	4515	5,9m i 2,95m

Jedinica mere: metar



mat srebro



sjaj srebro



brušena bronza

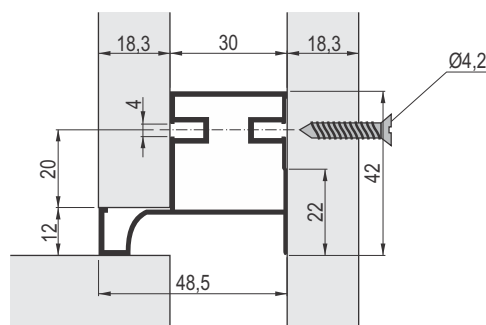
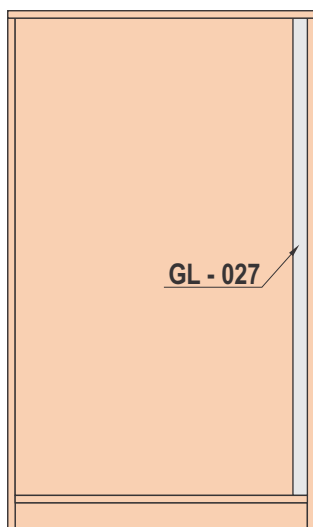

RU U GL - 027
GOLA - VERTIKALNA RUČICA

Aluminijumski profil koristi se kao vertikalna skrivena ručica prilikom izrade nameštaja od pločastog materijala. Uglavnom se postavlja na jednu od bočnih stranica korpusa. Završna obrada profila dobija se procesom hemijske eloksaže.



	šifra	Prodajne dužine
6 mat srebro	4510	6m, 3m i 2m
5,5 sjaj srebro	4511	5,5m i 2,75m
5,9 brušena bronza	4512	5,9m i 2,95m

Jedinica mere: metar



mat srebro



sjaj srebro



brušena bronza

PREGRADNI I VEZNI DEKORATIVNI PROFILI

- VP VEZNI „ H ” PROFILI - 180°
- VP VEZNI PROFILI - 90°
- „ T ” VEZNI PROFILI
- FLAH PROFILI

A close-up photograph showing a silver-colored metal profile being inserted into a pre-cut slot in a piece of light-colored wood. The wood grain is clearly visible. The metal profile has a T-shaped cross-section. The background is a dark, out-of-focus surface.

europofil



Jedinica mere: metar

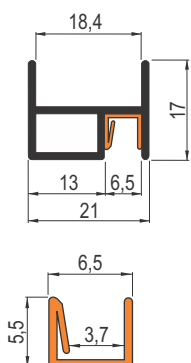

PVC ispuna 28007



VP 761 - H
VEZNI PROFIL

Al profil za spoj različitih pločastih materijala, debljine od 4 do 18mm u ugao od 180°. Profil 28007 je PVC ispuna koja odvaja staklo od aluminijuma.



3	mat srebro	275	Al profil
3	siva	227	PVC 28007



Jedinica mere: metar

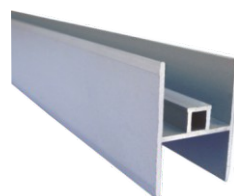
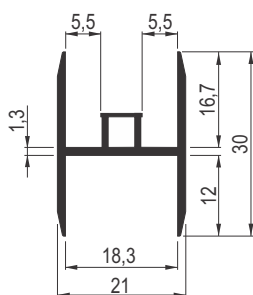

VP 1007 - A
VEZNI PROFIL

Al profil za spoj različitih pločastih materijala, debljine od 4 do 18mm u ugao od 180°. Za ovaj profil ne postoji PVC ispuna koja odvaja staklo od aluminijuma, zato bi stakla pre ugradnje trebalo adekvatno obraditi (kaljenje, brušenje, zaštitna folija).



3	mat srebro	723
---	------------	-----

* Pre ugradnje neophodna je obrada ivica stakla!

VP 1025 - H
VEZNI PROFIL

Al profil za spoj pločastih materijala, debljine do 18mm, u ugao od 180°.

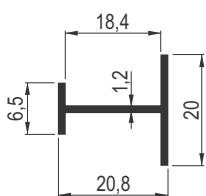

3	mat srebro	2590
3	sjaj srebro	6865
3	mat bronza	6866

Jedinica mere: metar

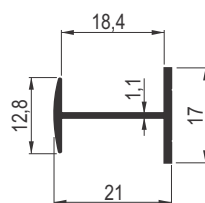

VP 1026 - H
VEZNI PROFIL

Al profil za spoj pločastih materijala, debljine do 18mm, u ugao od 180°.



3	mat srebro	2510
3	sjaj srebro	4880
3	mat bronza	4881

Jedinica mere: metar



Jedinica mere: metar

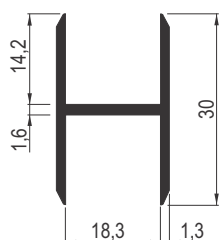

VP 1027 - C
VEZNI PROFIL

Al profil za spoj pločastih materijala, debljine do 18 mm, u ugao od 180°.



3	mat srebro	236
3	sjaj srebro	2797
3	mat bronza	3647



Jedinica mere: metar

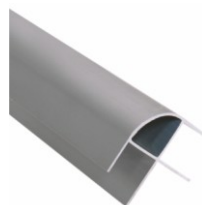
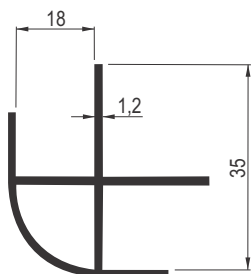

VP 1052
VEZNI PROFIL

Al profil za spoj pločastih materijala, debljine do 18 mm, pod uglom od 90°.



3	mat srebro	166
---	------------	-----

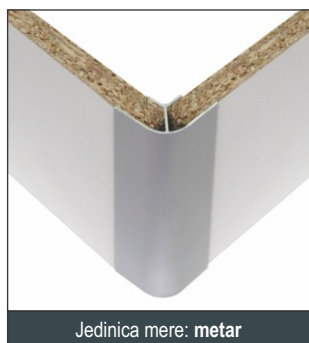

Jedinica mere: metar

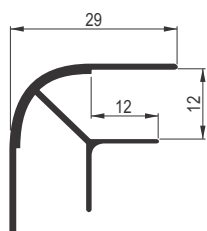

VP 1014 - D
VEZNI PROFIL

Al profil za spoj pločastih materijala, debljine do 12 mm, pod uglom od 90°.



3	mat srebro	703
---	------------	-----

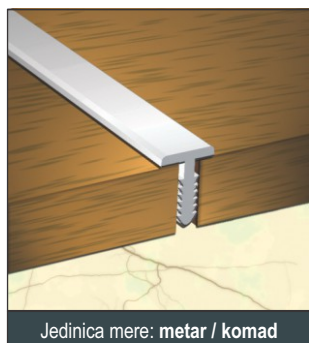

Jedinica mere: metar / komad

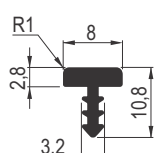

VP T 8mm
Al profil

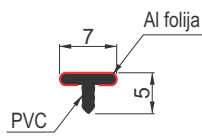

F - AL T - 07
PVC profil sa Al folijom



„ T ” VEZNI PROFILI

Al dekorativni vezni ukopavajući profili širine 7mm i 8mm za pločaste materijale.



3	mat srebro	887	3	mat srebro	2788
3	sjaj srebro	5461	3	sjaj srebro	2789
VP T 8mm			3	inox srebro	2790
Jedinica mere: metar					
F - AL T - 07					
Jedinica mere: komad					

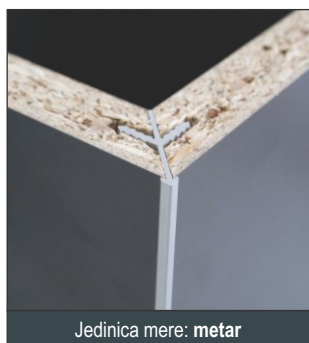

Jedinica mere: metar

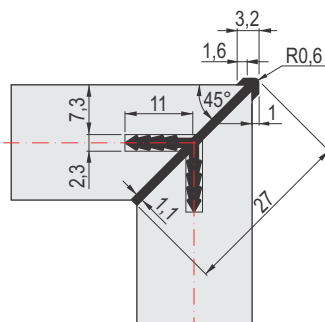

VP VEZNI PROFIL GER 90°

Vezni ger profil, predviđen je za spoj dve iverice u ugao od 90°. Koristi se kod spajanja pločastih materijala, oblaganja stubova, pravljenja polica...



3	mat srebro	6374
3	sjaj srebro	6375

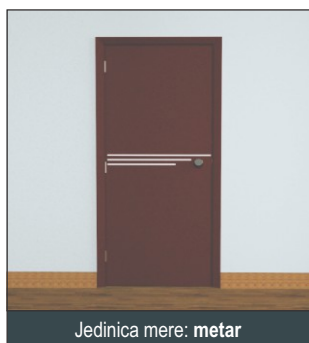

Jedinica mere: metar

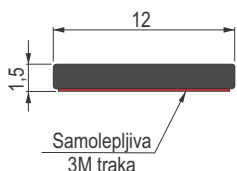

FLAH PROFIL 12 x 1,5mm

Profil se koristi da prikrije i dekoriše spoj različitih materijala, kao i da podeli određene celine. Profil je samolepljiv i dostupan je u dve dužine: 2,01m i 2,1m.



2	mat srebro	658
---	------------	-----

FLAH PROFIL 6 x 0,5mm / 12 x 0,5mm

Profil se koristi da prekrije i dekoriše spoj različitih materijala, kao i da podeli određene celine. Profili su samolepljivi, dužine 3m.

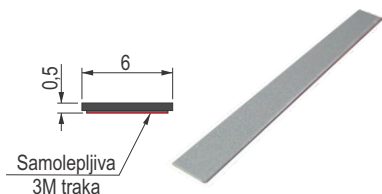

6 x 0,5mm

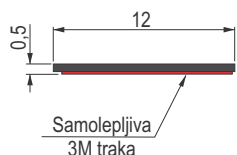

12 x 0,5mm



3	mat srebro	2184	3	mat srebro	2187
3	sjaj srebro	2185	3	sjaj srebro	2188
3	inox	2186	3	inox	2189

FLAH 6 x 0,5mm **FLAH 12 x 0,5mm**

Jedinica mere: komad

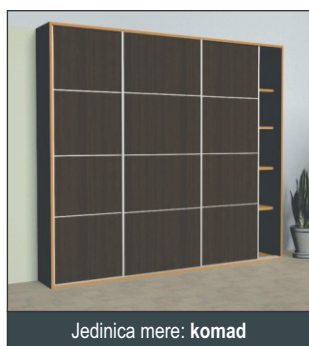

Jedinica mere: komad

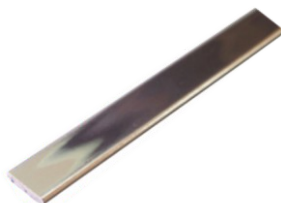
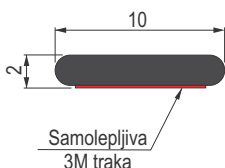

FLAH PROFIL 10 x 1,8mm

Profil se koristi da prekrije i dekoriše spoj različitih materijala, kao i da podeli određene celine (podele na plakarskim vratima, i sl.). Profili su samolepljivi, dužine 3m.



3	mat srebro	2786	3	inox	3650
3	sjaj srebro	2787	3	mat zlato	3839

FLAH PROFIL 6 x 1mm / 10 x 1mm

Profil se koristi da prikrije i dekoriše spoj različitih materijala, kao i da podeli određene celine. Profili su samolepljivi, dužine 3m.

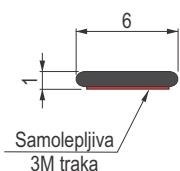

6 x 1mm

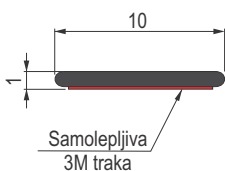

10 x 1mm



3	mat srebro	6894	3	mat srebro	6859
3	sjaj srebro	6895	3	sjaj srebro	6860
3	satén	6896	3	satén	6861

FLAH 6 x 1mm **FLAH 10 x 1mm**

Jedinica mere: komad

- LED NADGRADNI PROFILI
- LED UGRADNI PROFILI
- LED UGAONI PROFILI
- LED ZIDNI PROFILI
- LED PROFIL ZA KUHINJSKE COKLE
- LED PROFILI SA SENZOROM DODIRA I POKRETA



Jedinica mere: komad

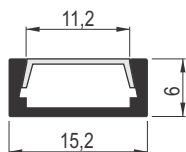

Metalni nosač

LED N 1506

NADGRADNI LED PROFIL

Aluminijumski nadgradni profili za LED diode sa belim i providnim PVC difuzorom (poklopcem), čepovima i nosačima. Aluminijumski profili su 2m i 3m dužine.

		šifra			šifra			šifra		
2	mat srebro	2737	3	mat srebro	4686	AL LED profili	kom	mat srebro	2738	PVC čep
2	bela	3516	3	bela	6134		kom	bela	4400	PVC čep
2	bela	2735	3	bela	4687	PVC poklopci	kom	sjaj	2744	nosač
2	providna	2739	3	providna	4906					



Jedinica mere: komad



PVC čep

PVC nosač

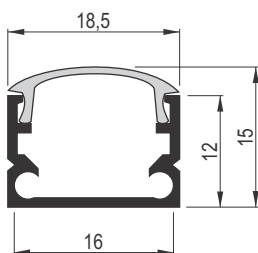

LED N 9029

NADGRADNI LED PROFIL

Aluminijumski nadgradni profil za LED rasvetu, sa belim i providnim PVC poklopcem i čepovima. Al LED profil i PVC poklopci su 3m dužine.

		šifra			šifra		
3	mat srebro	2513	AL LED	kom	siva	2515	PVC čep
3	bela	2514	PVC poklopac	kom	siva	4022	PVC nosač
3	providna	2520					



Jedinica mere: komad

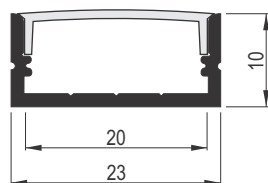
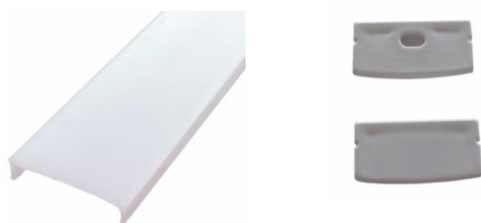

LED N 2310

NADGRADNI LED PROFIL

Aluminijumski nadgradni profili za LED rasvetu sa belim difuzorom (poklopcem) i čepovima u odgovarajućoj boji. Dužina LED profila 2310 je 2m.

		šifra			šifra		
2	mat srebro	3519	AL LED profili	kom	mat srebro	3523	PVC čep
2	bela	3520		kom	bela	3525	
2	bela	3521	poklopac				

 * Sve dužine su u metrima, ukoliko drugačije nije naznačeno.



Jedinica mere: komad



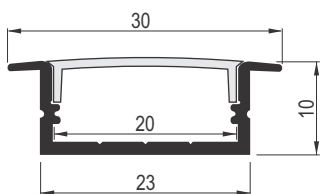

Širina ukopavajućeg kanala = 23,3mm



LED U 2810

UGRADNI LED PROFIL

Aluminijumski ugradni profili za LED rasvetu sa belim poklopcem i čepovima. Dužina LED profila je 2m.









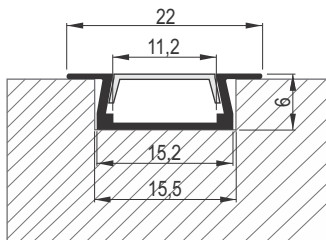

		šifra			šifra		
2	mat srebro	3517	AL LED profili	kom	mat srebro	3522	PVC čep
2	bela	3518		kom	bela	3524	
2	bela	3521	poklopac				



Jedinica mere: komad

Širina ukopavajućeg kanala = 15,5mm



		šifra			šifra			šifra			šifra			šifra		
2	mat srebro	2734	3	mat srebro	4685	2	bela	2735	3	bela	4687	kom	mat srebro	2736		
2	crna	6132	3	bela	523	2	providna	2739	3	providna	4906	kom	bela	6341		
2	bela	6340	AL LED profili				PVC poklopci - difuzori					kom	crna	6133		
AL LED profili															PVC čepovi	

LED U 2206

UGRADNI LED PROFIL

Aluminijumski ugradni profili za LED rasvetu sa belim i providnim difuzorom i čepovima. Profil je dostupan u dužinama od 2m i 3m.



Jedinica mere: komad



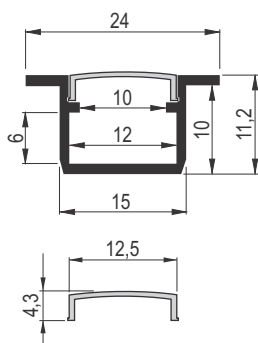



Širina ukopavajućeg kanala = 15,3mm



LED U 8607

UGRADNI LED PROFIL

Aluminijumski ukopavajući profil za LED rasvetu sa belim PVC poklopcem i sivim čepovima. Al LED profil je dužine 3m.

		šifra			šifra			šifra
3	mat srebro	2017	3	bela	2018	kom	siva	2019
AL LED profili			PVC poklopac			PVC čep		



Jedinica mere: komad



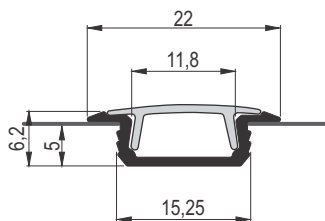



Širina ukopavajućeg kanala = 15,5mm



LED U GLAX

UGRADNI LED PROFIL

Aluminijumski ugradni profili za LED rasvetu sa belim i providnim poklopcem i čepovima. Dužina ugradnog GLAX LED profila je 2m.

		šifra			šifra			šifra
2	mat srebro	3107	2	bela	3108	kom	mat srebro	3110
AL LED profil			2	providna	3109	PVC čep		
PVC poklopac								

* Sve dužine su u metrima, ukoliko drugačije nije naznačeno.

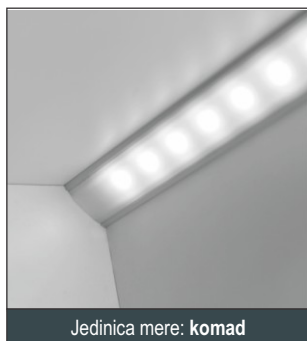

Jedinica mere: komad

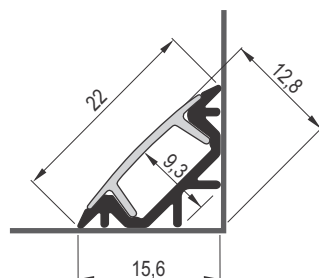

LED UGAO GLAX

UGAONI LED PROFIL

Aluminijumski ugaoni profili za LED rasvetu sa belim i providnim poklopcem i čepovima. Dužina ugaonog GLAX LED profila je 2m.

		šifra			šifra			šifra
2	mat srebro	4321	2	bela	3108	kom	mat srebro	4322
AL LED profil			2			providna 3109		
			PVC poklopac					

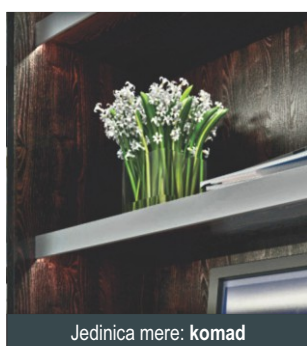

Jedinica mere: komad

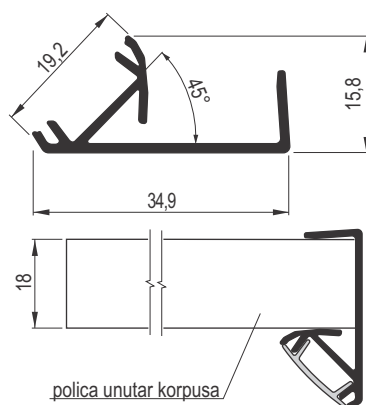

LED UGAO GLAX

JEDNOSTRANI UGAONI LED PROFIL

Profil omogućava da se LED traka postavi pod uglom od 45 stepeni. Jednostrani ugaoni profil pokriva kant police i osvetljava prostor unutar korpusa. Prodajna dužina jednostr. LED profila je 3m.

		šifra			šifra
3	mat srebro	5542	3	bela	592
AL LED profil			PVC poklopac		

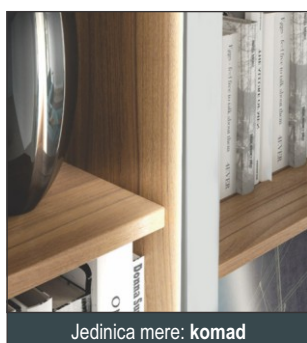

Jedinica mere: komad

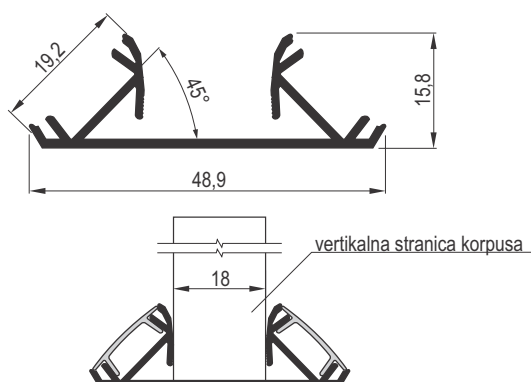

LED UGAO GLAX

DVOSTRANI UGAONI LED PROFIL

Profil omogućava da se LED traka postavi pod uglom od 45 stepeni. Dvostrani ugaoni profil pokriva vertikalne stranice korpusa i osvetljava prostor unutar korpusa. Prodajna dužina dvostr. LED profila je 3m.

		šifra			šifra
3	mat srebro	5543	3	bela	592
AL LED profil			PVC poklopac		



Jedinica mere: komad

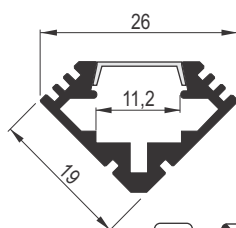

LED UGAO 1919

UGAONI LED PROFIL

Aluminijumski ugaoni profili za LED diode sa belim i providnim PVC difuzorom (poklopcem), čepovima i nosačima. Aluminijumski profili su 2m i 3m dužine.

		šifra			šifra			šifra
2	mat srebro	2740	3	mat srebro	4684	kom	mat srebro	2742
Al profil						PVC čep		
2	bela	2735	3	bela	4687	kom	sjaj	2743
PVC poklopci								
2	providna	2739	3	providna	4906			

 * Sve dužine su u metrima, ukoliko drugačije nije naznačeno.





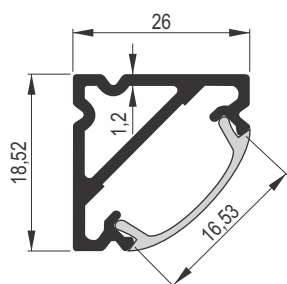

Jedinica mere: komad



LED UGAO 3729

UGAONI PROFIL

Aluminijumski ugaoni profili za LED diode sa belim i providnim poklopcem i čepovima. Aluminijumski LED profil je 3m dužine.

		šifra			šifra		
3	mat srebro	5215	Al profil	kom	mat srebro	5218	PVC čep
3	bela	5216	PVC poklopci				
3	providna	5217					





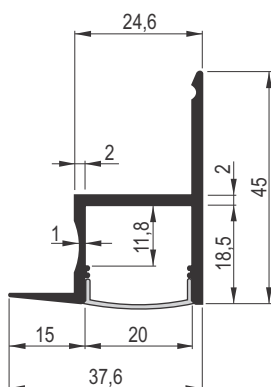

Jedinica mere: komad



LED ZID

Aluminijumski LED profil sa belim i providnim poklopcem za pregradne zidove, spuštene plafone i izradu nameštaja od ploč. materijala. Al LED profil za zid je 3m dužine.

		šifra			šifra
3	mat srebro	2230	3	bela	1834
3	bela	1934	PVC poklopac		
AL LED profil					





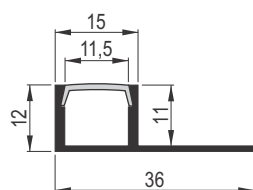

Jedinica mere: komad



LED AL PROFIL ZA KERAMIKU

Ugradni aluminijumski LED profil za keramiku debljine od 10mm do 12mm, kao i za izradu nameštaja od pločastih materijala. Al LED profil je 3m dužine.

		šifra			šifra
3	mat srebro	5510	3	bela	5464
3	bela	5511	3	providna	5466
AL LED profil			PVC poklopac		





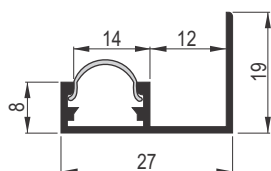

Jedinica mere: komad



LED AL PROFIL ZA PVC COKLU

Aluminijumski LED profil postavlja se u gornjoj zoni PVC cokle. Za Al LED profil za coklu postoje beli i providni PVC poklopci. Prodajna dužina profila je 3m.

		šifra			šifra
3	mat srebro	5547	3	bela	5548
AL LED profil			3	providna	5550
PVC poklopac					



Jedinica mere: set

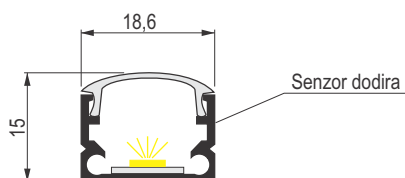

UP LED SENZOR DODIRA
NADGRADNI LED PROFIL

Dolazi u setu sa LED diodama, napajanjem (12V), čepovima i mlečnim poklopcem. Boja LED svetla je hladno bela. Sensor dodira uključuje svetlo, dodirom na bilo koji aluminijumski deo.

		šifra			šifra			šifra			šifra			šifra
0,40	mat srebro	4854	0,60	mat srebro	4856	0,80	mat srebro	4858	1	mat srebro	4860	1,2	mat srebro	593
0,50	mat srebro	4855	0,70	mat srebro	4857	0,90	mat srebro	4859	1,1	mat srebro	6003			



Jedinica mere: set

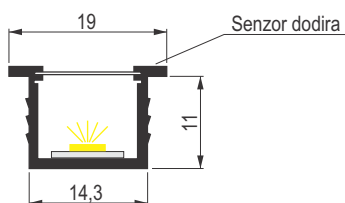

UP LED SENZOR DODIRA
UGRADNI LED PROFIL

Dolazi u setu sa LED diodama, napajanjem (12V), čepovima i mlečnim poklopcem. Boja LED svetla je hladno bela. Sensor dodira uključuje svetlo, dodirom na bilo koji aluminijumski deo.

		šifra			šifra			šifra			šifra
0,60	mat srebro	4555	0,80	mat srebro	4557	1	mat srebro	4559	1,2	mat srebro	4561
0,70	mat srebro	4556	0,90	mat srebro	4558	1,1	mat srebro	4560	1,5	mat srebro	4562



Jedinica mere: set

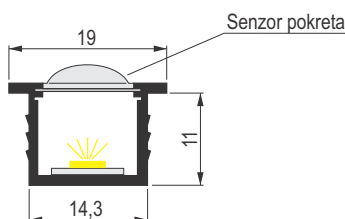

UP LED SENZOR POKRETA
UGRADNI LED PROFIL

Dolazi u setu sa LED diodama, napajanjem (12V), čepovima i mlečnim poklopcem. Boja LED svetla je hladno bela. Sensor pokreta uključuje svetlo, prelaskom šake preko okna senzora.

		šifra			šifra			šifra			šifra
0,60	mat srebro	4563	0,80	mat srebro	4565	1	mat srebro	4567	1,2	mat srebro	4569
0,70	mat srebro	4564	0,90	mat srebro	4566	1,1	mat srebro	4568	1,5	mat srebro	4570

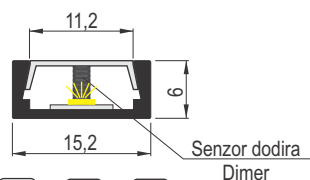

		šifra
2	mat srebro	5513
Jedinica mere: komad		

LED senzor dodira / 2m
NADGRADNI

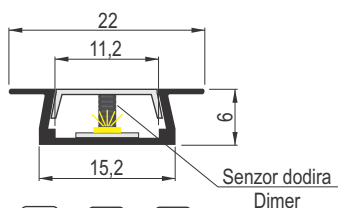

		šifra
2	mat srebro	5512
Jedinica mere: komad		

LED senzor dodira / 2m
UGRADNI

UP LED SENZOR DODIRA
UGRADNI / NADGRADNI LED PROFIL

Dolaze u setu sa LED diodama, napajanjem (12V), čepovima i mlečnim poklopcem. Boja LED svetla je hladno bela. Sensor dodira uključuje svetlo, dodirom na pločicu na predviđenom delu poklopcu, na kojem se nalazi i dimer svetla. Dimer se aktivira pritiskom dužim od 2 sek.

LED ugradni i nadgradni profil moguće je praviti po željenim dimenzijama.
Rok isporuke od 7 do 10 dana.

ALUMINIJUMSKI KANT I PULT PROFILI

- KP AL KANT PROFILI ZA DRVENU ISPUNU DEBLJINE:

- 6mm
- 10mm
- 16,2mm
- 18,2mm
- 18,3mm
- 18,75mm
- 19mm
- 25mm
- 36mm
- 40mm

- AL PULT PROFILI

- 40mm
- 60mm



Jedinica mere: komad

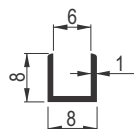

KP 1028 / 6mm

KANT PROFIL

Simetrični Al kant profil namenjen je za kantovanje materijala debljine do 6mm. Prodajna dužina kant profila je 3m.



3	mat srebro	4093
---	------------	------



Jedinica mere: komad

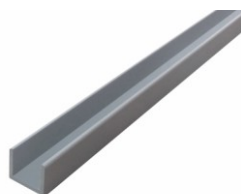
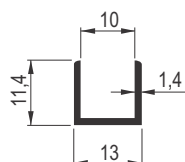

KP 1028 / 10mm

KANT PROFIL

Simetrični Al kant profil namenjen je za kantovanje materijala debljine do 10mm. Prodajna dužina kant profila je 3m.



3	mat srebro	637
---	------------	-----

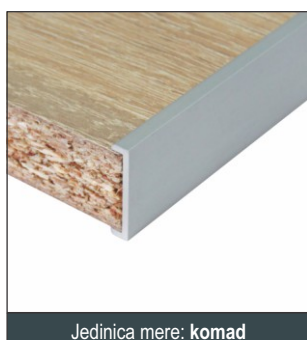

Jedinica mere: komad

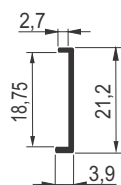

KP 47 / 18,75

KANT PROFIL

Aluminijumski kant profil 47 / 18,75mm namenjen je za pločaste materijale debljine do 18,75mm. Al profil je veoma savitljiv. Prodajna dužina kant profila je 3m.



3	mat srebro	381
---	------------	-----



Jedinica mere: komad

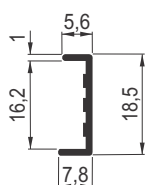

KP 48 / 16,2 AS

KANT PROFIL

Asimetrični Al kant profil 48 / 16,2mm namenjen je za pločaste materijale debljine do 16,2mm. Prodajna dužina kant profila je 3m.



3	mat srebro	4595
---	------------	------





Jedinica mere: komad

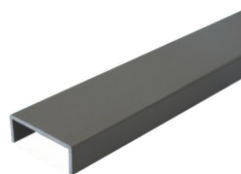
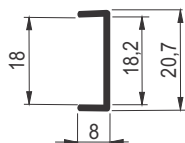

KP 48 / 18,2

KANT PROFIL

Aluminijumski kant profil 48 / 18,2mm namenjen je za pločaste materijale debljine do 18,2mm.

Prodajna dužina kant profila je 3m.



3	mat srebro	241	3	mat bronza	497
3	brušena bronza	4602	3	sjaj srebro	654



Jedinica mere: komad

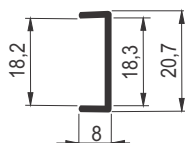

KP 48 / 18,3

KANT PROFIL

Aluminijumski kant profil 48 / 18,3mm namenjen je za pločaste materijale debljine do 18,3mm.

Prodajna dužina kant profila je 2,98m.



2,98	mat srebro	348	2,98	sjaj srebro	349
2,98	mat zlato	496			



Jedinica mere: komad

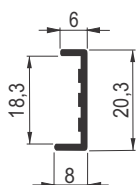

KP 48 / AS - R

KANT PROFIL

Asimetrični Al kant profil 48 / AS - R je rebrast sa unutrašnje strane i namenjen je za pločaste materijale debljine do 18,3mm.

Prodajna dužina kant profila je 3m.



3	mat srebro	1020
---	------------	------



Jedinica mere: komad

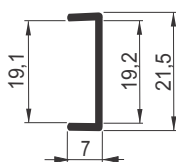

KP 48 / 19

KANT PROFIL

Al kant profil 48 / 19 namenjen je za pločaste materijale debljine do 19mm.

Prodajna dužina kant profila je 2,98m.



2,98	mat srebro	384	2,98	mat bronza	498
2,98	mat zlato	500	2,98	sjaj srebro	499



Jedinica mere: komad

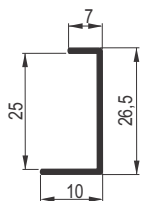

KP 48 / 25
KANT PROFIL

Asimetrični Al kant profil 48 / 25 namenjen je za pločaste materijale debljine do 25mm (radne ploče).

Prodajna dužina kant profila je 2,98m.



2,98	mat srebro	491	2,98	mat bronza	489
2,98	mat zlato	488	2,98	sjaj srebro	490



Jedinica mere: komad

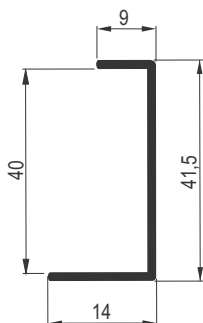

KP 48 / 40
KANT PROFIL

Asimetrični Al kant profil 48 / 40 namenjen je za pločaste materijale debljine do 40mm (radne ploče).

Prodajna dužina kant profila je 2,98m.



2,98	mat srebro	493	2,98	mat bronza	494
2,98	sjaj srebro	495			



Jedinica mere: komad

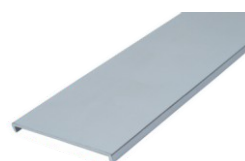
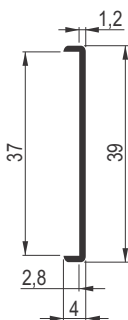

KP 1029 E / 36mm
KANT PROFIL

Simetrični Al kant profil 1029 E namenjen je za kantovanje materijala debljine do 36 - 37mm (dva spojena univera). Al kant profil je veoma savitljiv.

Prodajna dužina kant profila je 3m.



3	mat srebro	303	3	sjaj srebro	600
---	------------	-----	---	-------------	-----



Jedinica mere: komad

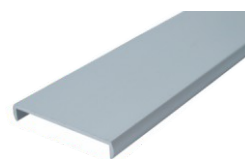
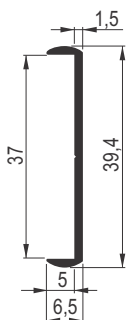

KP 1029 G / 36mm
KANT PROFIL

Simetrični Al kant profil 1029 G namenjen je za kantovanje materijala debljine do 36 - 37mm (dva spojena univera).

Prodajna dužina kant profila je 3m.



3	mat srebro	414	3	sjaj srebro	601
---	------------	-----	---	-------------	-----



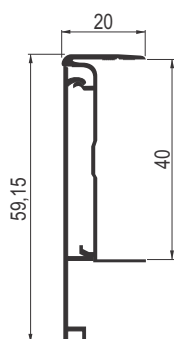

Jedinica mere: metar



AL PULT PROFIL 6 cm

Al pult profil za čeone površine debljine do 40mm, sa maskom 60mm. Sastoji se iz dva dela, i ima odgovarajući spoljašnji i unutrašnji ugao.

		šifra	Prodajne dužine
4,2	mat srebro	549	2,1m i 4,2m



		šifra
kom	mat srebro	551

Al unutrašnji ugao za pult profil 6cm

		šifra
kom	mat srebro	550

Al spoljašnji ugao za pult profil 6cm

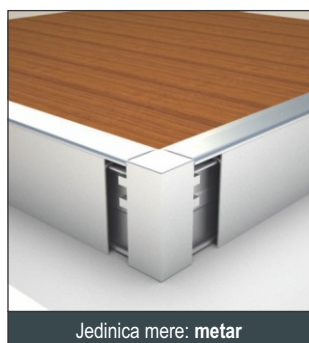

Jedinica mere: metar

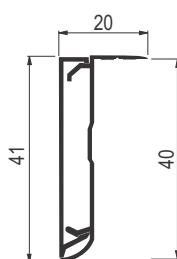

AL PULT PROFIL 4 cm

Al pult profil za čeone površine, debljine do 40 mm. Sastoji se iz dva dela, i ima odgovarajući spoljašnji i unutrašnji ugao.

		šifra	Prodajne dužine
4,2	mat srebro	746	2,1m i 4,2m



		šifra
kom	mat srebro	911

Al unutrašnji ugao za pult profil 4cm

		šifra
kom	mat srebro	912

Al spoljašnji ugao za pult profil 4cm

QP PROFILI ZA IZRADU QUADRO OTVORENIH POLICA PO MERI

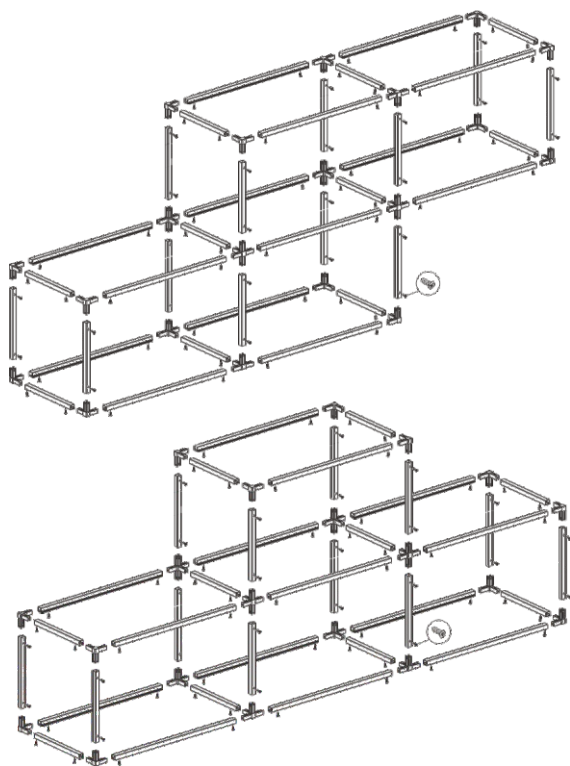

ONP ALUMINIJUMSKI PROFILI ZA IZRADU ZIDNIH STAKLENIH I DRVENIH POLICA

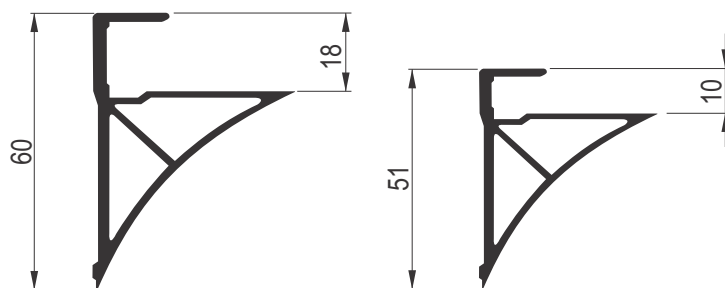

PANO PROFILI ZA IZRADU POLICA ZA IZLAGANJE ROBE I KAČENJE ŽIČNIH ELEMENTATA

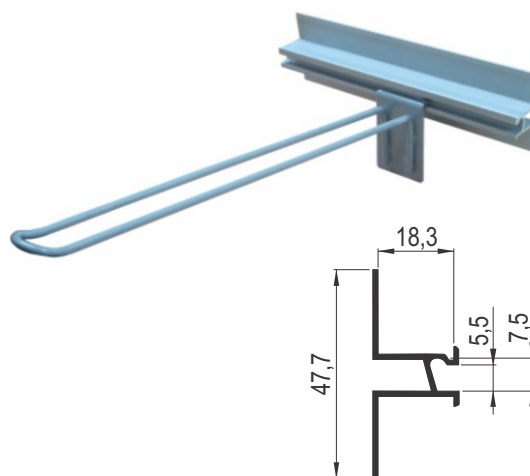
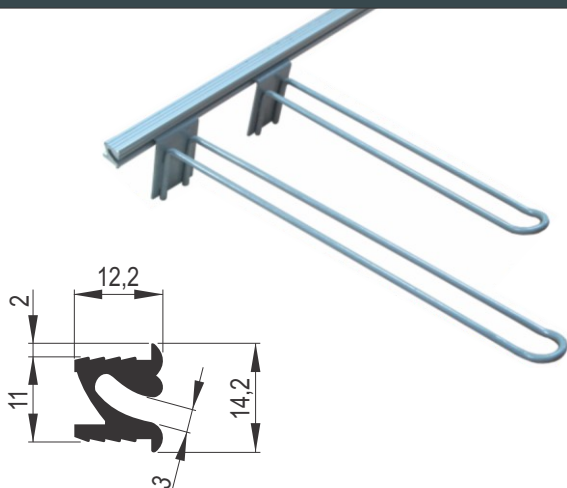



MODULARNI SISTEM ZA OTVORENE POLICE - QUADRO



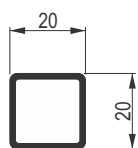

QP 2719



		šifra
4	mat crna	6479
Jedinica mere: metar		

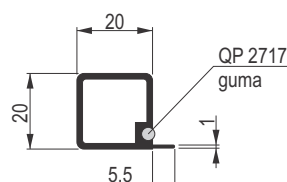

QP 2717



		šifra
4	mat crna	6480
Jedinica mere: metar		

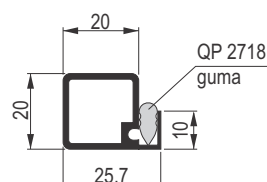

QP 2718



		šifra
4	mat crna	6481
Jedinica mere: metar		

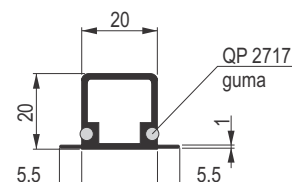

QP 2720

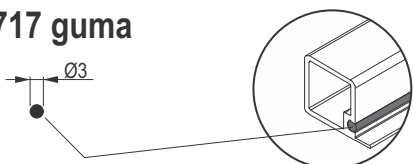

		šifra
4	mat crna	6910
Jedinica mere: metar		

QP 2717 guma





		šifra
m	mat crna	6485
Jedinica mere: metar		

Guma QP 2717, upotrebljavaju se kada je potrebno napraviti police od drveta debljine 18mm.

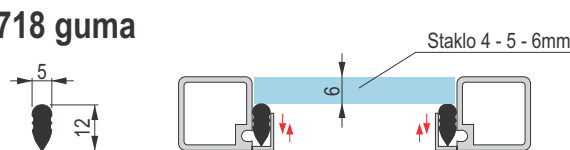
QP 2718 guma



		šifra
m	mat crna	6484
Jedinica mere: metar		

Guma QP 2718 može da se podiže ili spušta, u zavisnosti od debljine stakla. Quadro staklene police su predviđene za stakla debljine od 4 - 6mm.

QP Metalni ugao 3 kraka

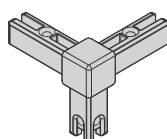

		šifra
kom	mat crna	6482
Jedinica mere: komad		

QP Metalni ugao 4 kraka - vezni

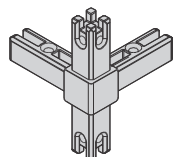

		šifra
kom	mat crna	6483
Jedinica mere: komad		

QP Metalni ugao 5 krakova

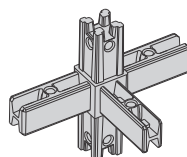

		šifra
kom	mat crna	6911
Jedinica mere: komad		

QP Metalni ugao 4 kraka - završni

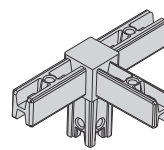

		šifra
kom	mat crna	6912
Jedinica mere: komad		

QP Metalni šraf M5 x 12mm



		šifra
kom	mat crna	6486
Jedinica mere: komad		

QP Metalni uglovi imaju urezane navoje sa gornje i sa donje strane, što omogućava spajanje sa profilima tako da se šrafovi ne vide nakon montaže.

Profili za izradu policica, izlaganje robe i kačenje žičanih elemenata

 * Sve dužine su u metrima, ukoliko drugačije nije naznačeno.

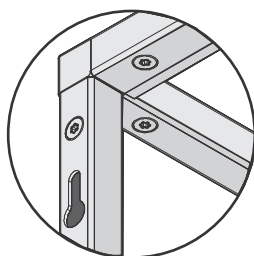

Otvori za zidno kačenje pripremaju se na zahtev!

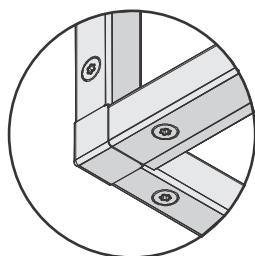

Zahvaljujući uglovima koji imaju urezan navoj sa obe strane, šrafove je moguće postaviti sa gornje ili sa donje strane Al profila. Ova opcija omogućava sakrivanje šrafova u odnosu na poziciju policice u prostoru.



QP QUADRO - STANDARD

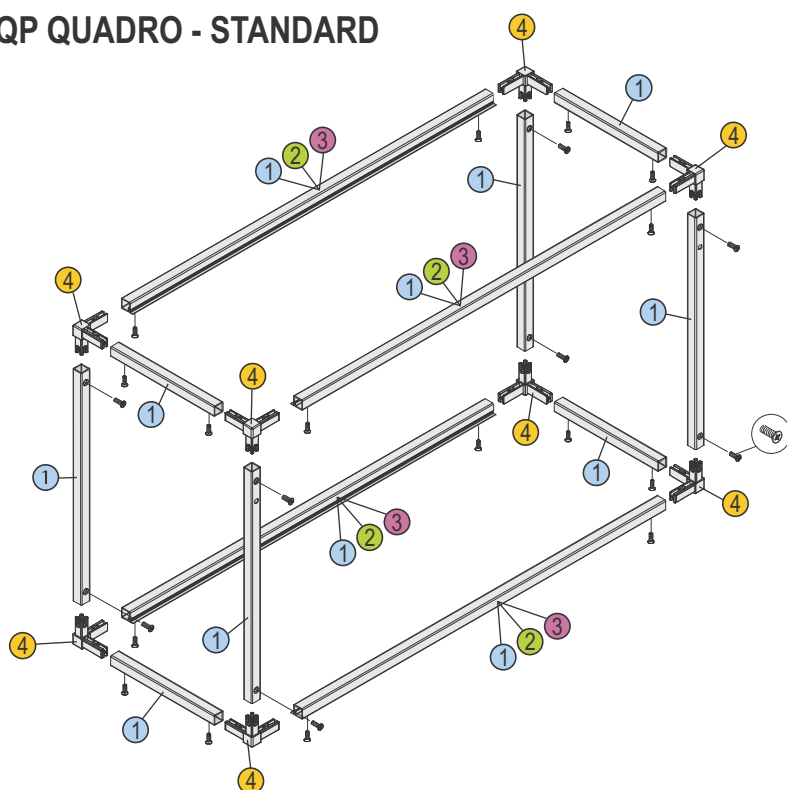

QP 2719

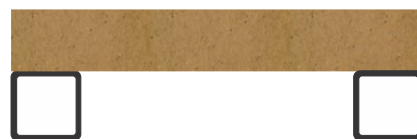

Koristi se uglavnom kao vertikalni profil, a po potrebi može se koristiti i kao horizontalni profil.

QP 2717

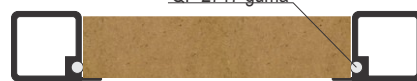

Koristi se kao horizontalni profil namenjen za izradu drvenih policica debljine 18mm.

Guma QP 2717 - služi da odvoji drvenu ispunu od Al profila.

QP 2718

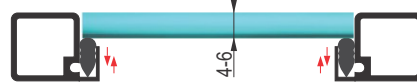

Koristi se kao horizontalni profil namenjen za izradu staklenih policica debljine od 4 - 6mm.

Guma QP 2718 - može da se podiže ili spušta, u zavisnosti od debljine stakla.

QP Metalni ugao 3 kraka

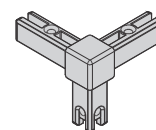

	Šifra	Naziv proizvoda
1	6479	QP 2719
2	6480	QP 2717
3	6481	QP 2718
4	6482	QP Metalni ugao tri kraka

Napomena:

1. Gotove Quadro police po meri isporučujemo sklopljene, ili u delovima koji su pripremljeni za sklapanje i montažu.
2. Guma i šrafovi su uključeni u cenu i dolaze zajedno u kompletu sa gotovim Quadro policama.
3. Maksimalna dozvoljena širina Quadro policica je 1200mm bez preklopa, maksimalna dubina je 500mm, a visina je ograničena dužinom vertikalnog profila (3m).
4. Za specifične izgleda policica, molimo Vas da nas kontaktirate na: europrofil.rs/kontakt

Profili za izradu polica, izlaganje robe i kačenje žičanih elemenata

 * Sve dužine su u metrima, ukoliko drugačije nije naznačeno.

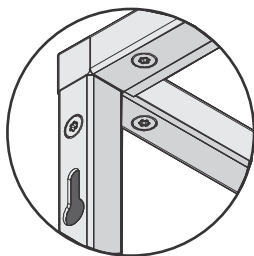

Otvori za zidno kačenje pripremaju se na zahtev!

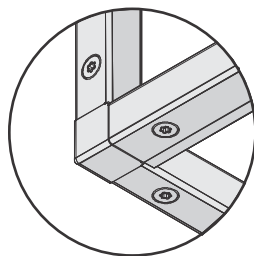

Zahvaljujući uglovima koji imaju urezan navoj sa obe strane, šrafove je moguće postaviti sa gornje ili sa donje strane Al profila. Ova opcija omogućava sakrivanje šrafova u odnosu na poziciju police u prostoru.



QP QUADRO - NA SPRAT

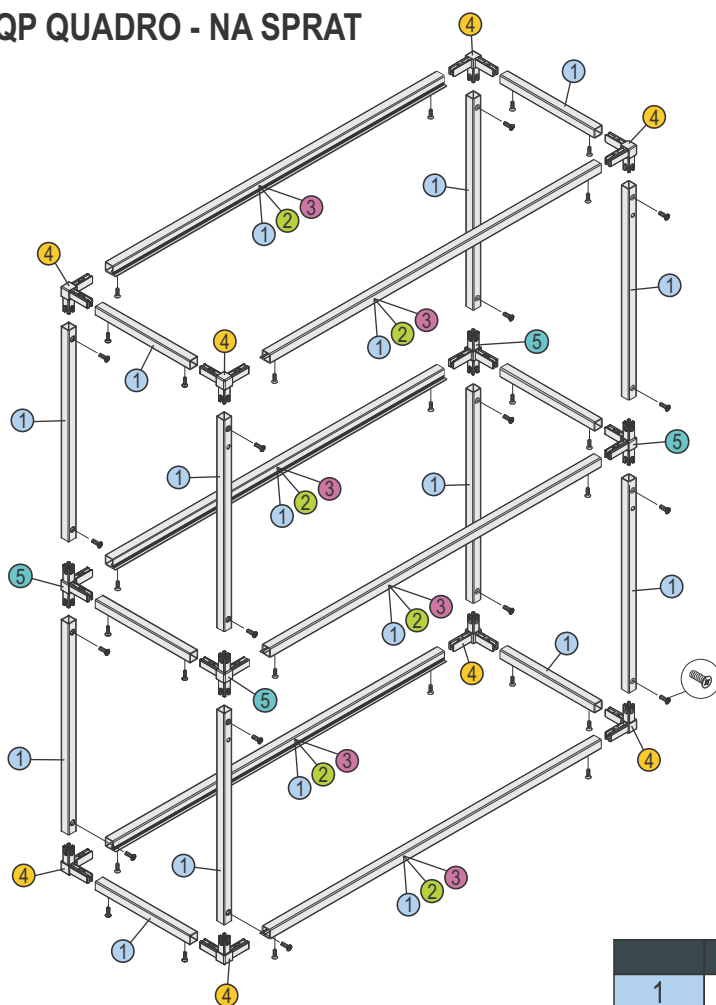

QP 2719

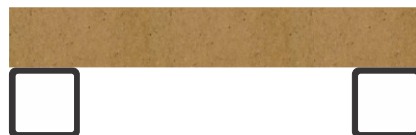

Koristi se uglavnom kao vertikalni profil, a po potrebi može se koristiti i kao horizontalni profil.

QP 2717

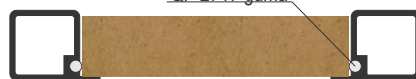

Koristi se kao horizontalni profil namenjen za izradu drvenih polica debljine 18mm.

Guma QP 2717 - služi da odvoji drvenu ispunu od Al profila.

QP 2718

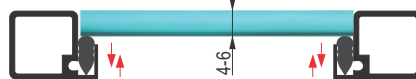

Koristi se kao horizontalni profil namenjen za izradu staklenih polica debljine od 4 - 6mm.

Guma QP 2718 - može da se podiže ili spušta, u zavisnosti od debljine stakla.

QP Metalni ugao 3 kraka

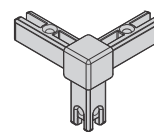

QP Metalni ugao 4 kraka - vezni

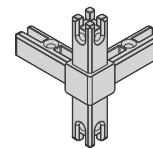

	Šifra	Naziv proizvoda
1	6479	QP 2719
2	6480	QP 2717
3	6481	QP 2718
4	6482	QP Metalni ugao tri kraka
5	6483	QP Metalni ugao četiri kraka - vezni

Napomena:

1. Gotove Quadro police po meri isporučujemo sklopljene, ili u delovima koji su pripremljeni za sklapanje i montažu.
2. Guma i šrafovi su uključeni u cenu i dolaze zajedno u kompletu sa gotovim Quadro policama.
3. Maksimalna dozvoljena širina Quadro polica je 1200mm bez prekida, maksimalna dubina je 500mm, a visina je ograničena dužinom vertikalnog profila (3m).
4. Moguće je spajanje po visini u više nivoa nego što je prikazano na primeru. Za specifične izgleda polica, molimo Vas da nas kontaktirate na: europrofil.rs/kontakt

Profili za izradu polica, izlaganje robe i kačenje žičanih elemenata

* Sve dužine su u metrima, ukoliko drugačije nije naznačeno.

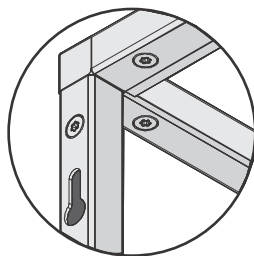

Otvori za zidno kačenje pripremaju se na zahtev! Zahvaljujući uglovima koji imaju urezan navoj sa obe strane, šrafove je moguće postaviti sa gornje ili sa donje strane Al profila. Ova opcija omogućava sakrivanje šrafova u odnosu na poziciju police u prostoru.



QP QUADRO - SPOJENE POLICE

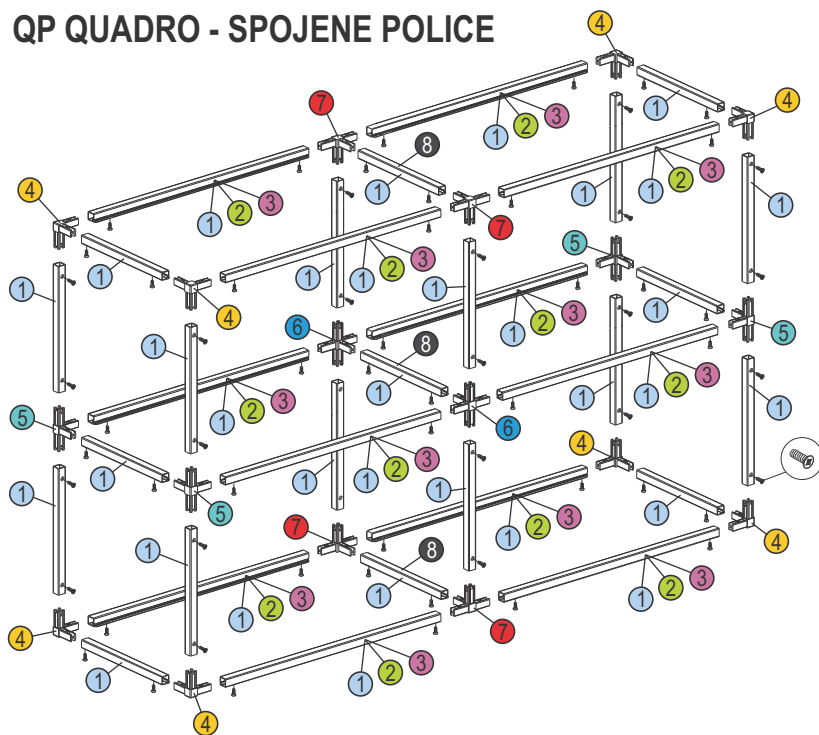

Koristi se kao horizontalni profil namenjen za izradu drvenih polica debljine 18mm. Najčešće se postavlja između dve police, prilikom spajanja polica.

	Šifra	Naziv proizvoda
1	6479	QP 2719
2	6480	QP 2717
3	6481	QP 2718
4	6482	QP Metalni ugao 3 kraka
5	6483	QP Metalni ugao 4 kraka - vezni
6	6911	QP Metalni ugao 5 krakova
7	6912	QP Metalni ugao 4 kraka - završni
8	6910	QP 2720

Napomena:

1. Gotove Quadro police po meri isporučujemo sklopljene, ili u delovima koji su pripremljeni za sklapanje i montažu.
2. Guma i šrafovi su uključeni u cenu i dolaze zajedno u kompletu sa gotovim Quadro policama.
3. Maksimalna dozvoljena širina Quadro polica je 1200mm bez prekida, maksimalna dubina je 500mm, a visina je ograničena dužinom vertikalnog profila (3m).
4. Moguće je spajanje po visini i širini u više nivoa nego što je prikazano na primeru. Za specifične izgleda polica, molimo Vas da nas kontaktirate na: europrofil.rs/kontakt

QP 2719

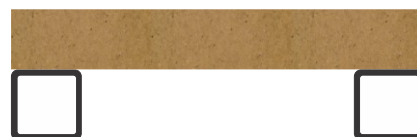

Koristi se uglavnom kao vertikalni profil, a po potrebi može se koristiti i kao horizontalni profil.

QP 2717

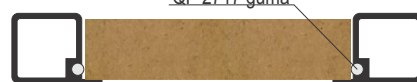

Koristi se kao horizontalni profil namenjen za izradu drvenih polica debljine 18mm.

Guma QP 2717 - služi da odvoji drvenu ispunu od Al profila.

QP 2718



Koristi se kao horizontalni profil namenjen za izradu staklenih polica debljine od 4 - 6mm.

Guma QP 2718 - može da se podiže ili spušta, u zavisnosti od debljine stakla.

QP Metalni ugao 3 kraka

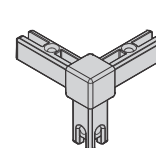

QP Metalni ugao 4 kraka - vezni

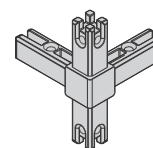

QP Metalni ugao 5 krakova

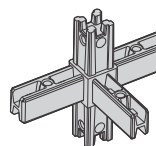

QP Metalni ugao 4 kraka - završni

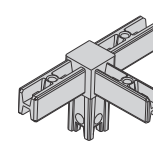

Profili za izradu polica, izlaganje robe i kačenje žičanih elemenata

* Sve dužine su u metrima, ukoliko drugačije nije naznačeno.



Jedinica mere: metar

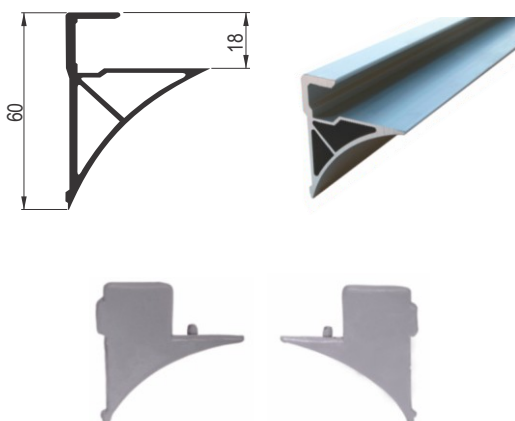

ONP 1045 D / 18mm

Al dekorativni profil sa PVC čepovima za drvene police. Maksimalna debljina materijala iznosi 18mm.



3	mat srebro	304	Al profil
kom	mat siva	345/D	PVC čep
kom	mat siva	345/L	

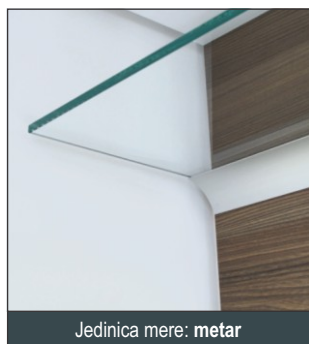

Jedinica mere: metar

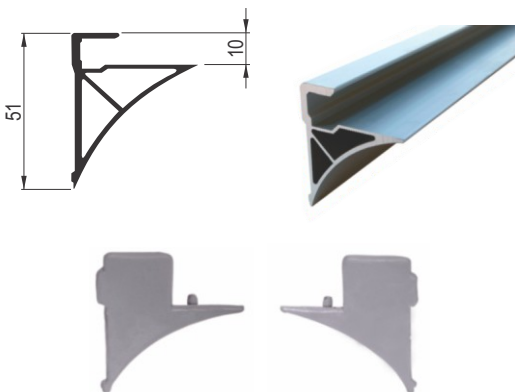

ONP 1045 D / 10mm

Al dekorativni profil sa PVC čepovima za staklene ili drvene police. Maksimalna debljina materijala je 10mm.



3	mat srebro	2726	Al profil
kom	mat siva	3150 D	PVC čep
kom	mat siva	3150 L	

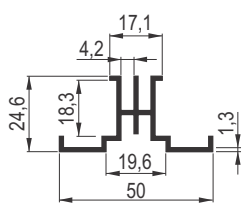

SM 1068 F

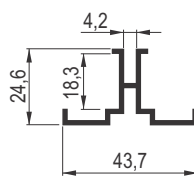

SM 1068 N



PANO 1068 F / 1068 N

Aluminijumski pano profili za kačenje polica za debljinu iverice 18mm. Al profil 1068 F ima mogućnost montiranja nosača u paru i koristi se kada je potrebno napraviti police za veću nosivost. Al profil 1068 N može da koristi samo jedan nosač po profilu. Dužina metalnog nosača je 25cm.



2,5	mat srebro	3670	SM 1068 F
2,7	mat srebro	3671	SM 1068 N

Jedinica mere: metar



0,25	srebro mat	5724	met. nosač
------	------------	------	------------

Jedinica mere: par



Jedinica mere: metar / par

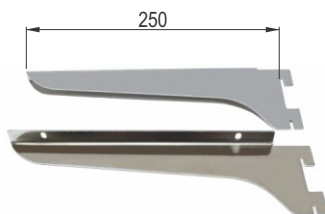

Metalni nosači



1068 N



1068 F

Profili za izradu polica, izlaganje robe i kačenje žičanih elemenata

 * Sve dužine su u metrima, ukoliko drugačije nije naznačeno.

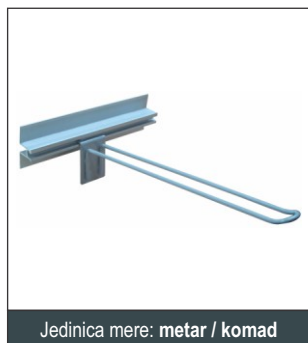



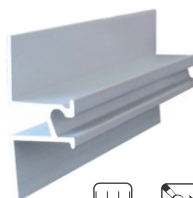
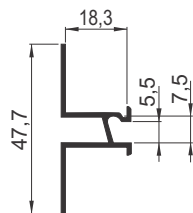

Jedinica mere: metar / komad



PANO 2038

Al pano profil za izlaganje robe. PANO profil 2038 može da posluži kao nosač kuhinjskih žičanih elemenata.

		šifra			šifra	metalni 2k. nosači	
3	mat srebro	1881	Al profil	0,20	mat srebro		4468
Jedinica mere: metar				0,25	mat srebro	4467	Jedinica mere: komad

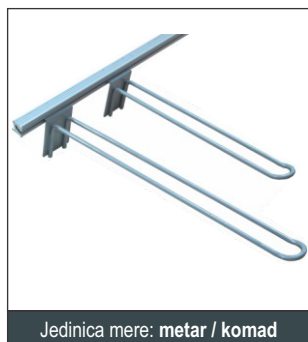



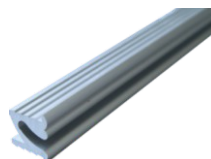
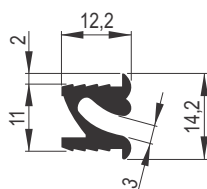

Jedinica mere: metar / komad



PANO 1038 D

Al ukopavajući profil za kačenje žičanih elemenata. Za Al PANO profil 1038 D, dostupni su 2k. metalni nosači dužine 20cm i 25cm.

		šifra			šifra	metalni 2k. nosači	
3	mat srebro	909	Al profil	0,20	mat srebro		4470
Jedinica mere: metar				0,25	mat srebro	4469	Jedinica mere: komad

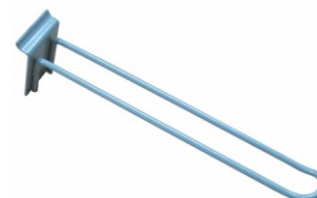



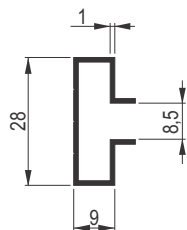

Jedinica mere: metar / komad



PANO 1038

Al ukopavajući profil za kačenje žičanih elemenata. Za Al PANO profil 1038 dostupni su 2k. nosači od 20cm i 25cm dužine, i 1k. nosač 25cm dužine.

		šifra			šifra	met. 2k. nosači	
3	mat srebro	4591	Al profil	0,20	sjaj srebro		4593
Jedinica mere: metar				0,25	sjaj srebro	4592	Jedinica mere: komad
				0,25	sjaj srebro	4594	

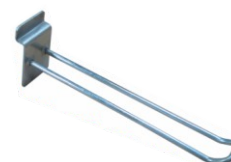

PVC I ALUMINIJUMSKE COKLE

- CN PVC DIHT COKLA ZA KANT UNIVERA 18mm
- LED AL PROFIL ZA PVC COKLU
- CN PVC COKLA ZA KUHINJSKE ELEMENTE
- CN ELEMENTI ZA PVC COKLE

- CN AL LED COKLA
- CN AL COKLA GLATKA
- CN AL COKLA RELJEFNA
- CN ELEMENTI ZA AL COKLE
- AL TABLA 100 x 2000mm FLAH



europrofil

* Sve dužine su u metrima, ukoliko drugačije nije naznačeno.



Jedinica mere: metar

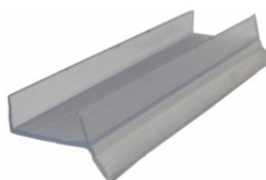
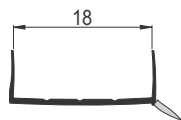

CN PVC Diht kant

PVC diht cokla koristi se kada je potrebno sprečiti prodor vlage u ivericu. Najčešće se postavlja na elementima koji su izloženi uticaju vlage (kuhinjske cokle i sl...).



3,6	providna	139
-----	----------	-----



Jedinica mere: metar

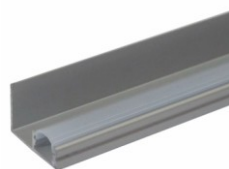
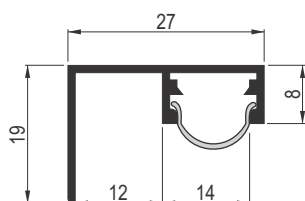

LED AL PROFIL ZA PVC COKLU

Aluminijumski LED profil postavlja se u gornjoj zoni PVC cokle.

Za Al LED profil za coklu postoje beli i providni PVC poklopci. Prodajna dužina profila je 3m.



3	mat srebro	5547	3	bela	5548
AL LED profil			3	providna	5550
PVC poklopac					

CN PVC COKLA ZA KUHINJSKE ELEMENTE

PVC cokla se koristi za spoj kuhinjskih elemenata i poda. Za nogice kuhinjskih elementa veže se pomoću odgovarajuće PVC šnale. Osnova ove cokle je PVC profil koji je obložen odgovarajućom folijom (bela, Al Inox, Al brušena, pvc mat srebro i pvc reljefna). Dužina PVC sokle je 4m. Visina PVC cokle je: 10cm, 12cm i 15cm. Sve PVC cokle na sebi imaju meki silikonski profil koji naleže na pod i stvara nepropusni spoj cokle i podne obloge.



PVC folija
Bela



PVC folija
Reljefna - Mat srebro



Al folija
Brušena



PVC folija
Mat srebro



Al folija
Inox

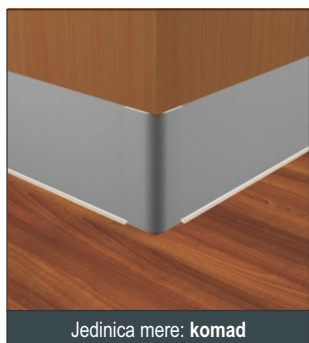

Jedinica mere: komad



4	al.folija brušena	2491
4	al.folija inox	2972
4	pvc mat srebro	428
4	mat sr. reljefna	429
4	sjaj bela	2749
4	mat bela	5549

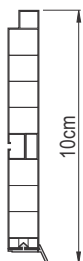

H = 10cm



4	al.folija brušena	2492
4	al.folija inox	2973
4	pvc mat srebro	531
4	pvc reljefna	1822
4	sjaj bela	4086

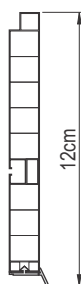

H = 12cm



4	al.folija brušena	2493
4	al.folija inox	2974
4	pvc mat srebro	1762
4	pvc reljefna	2494
4	sjaj bela	4087



H = 15cm

 * Sve dužine su u metrima, ukoliko drugačije nije naznačeno.

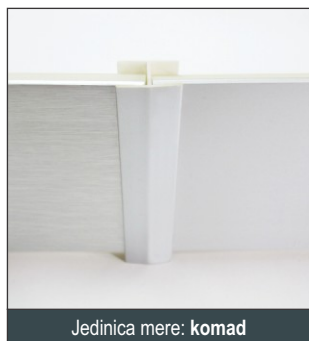

Jedinica mere: komad

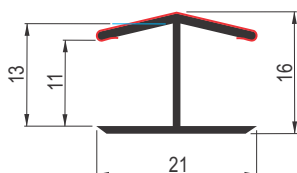

CN PVC NASTAVAK

PVC nastavak omogućava kruti spoj između dve PVC cokle. Osnova nastavka je PVC profil koji je obložen odgovarajućom folijom (bela, Al brušena, sr. mat). PVC nastavak dostupan je u dužinama: 10, 12 i 15cm.

		šifra			šifra			šifra
10cm	srebro mat	4077	12cm	srebro mat	4078	15cm	srebro mat	4079
10cm	al. folija brušena	4083	12cm	al. folija brušena	4084	15cm	al. folija brušena	4085
10cm	bela sjaj	4080	12cm	bela sjaj	4081	15cm	bela sjaj	4082

* Dužine PVC nastavka izražene su u centimetrima.





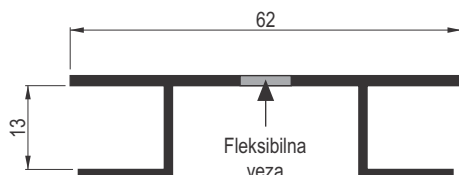





Jedinica mere: komad



CN PVC UGAO za PVC coklu savitljivi

Fleksibilna veza omogućava pravljenje više različitih uglova prilikom spajanja cokli. PVC ugao je obložen odgovarajućom folijom: (sr. mat i inox). PVC nastavak dostupan je u dužinama: 10, 12 i 15cm.

		šifra			šifra			šifra			šifra
10cm	Al. folija brušena	6877	10cm	sr. mat	1935	12cm	sr. mat	1938	15cm	sr. mat	1941
10cm	Al. folija inox	6878	10cm	inox	1937	12cm	inox	1939	15cm	inox	1942

* Dužine PVC savitljivog ugla izražene su u centimetrima.





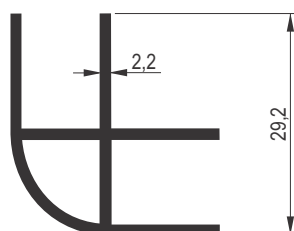



Jedinica mere: komad



UGAO 90° ZA PVC COKLU

Osnova PVC ugla je profil obložen odgovarajućom folijom (inox, Al brušena, sr. mat). PVC ugao dostupan je u dužinama: 10, 12 i 15cm.

		šifra			šifra			šifra
10cm	al. folija brušena	2769	12cm	al. folija brušena	2770	15cm	al. folija brušena	2771
10cm	mat srebro	1998	12cm	mat srebro	431	15cm	mat srebro	1995
10cm	al. folija inox	3147	12cm	al. folija inox	3148	15cm	al. folija inox	3149

* Dužine PVC ugla 90° izražene su u centimetrima.



Jedinica mere: komad



CN PVC šnale za cokle

Šnale se koriste za spajanje cokli za predviđene nogice kuhinjskih elemenata.

		šifra
kom	bela	1768

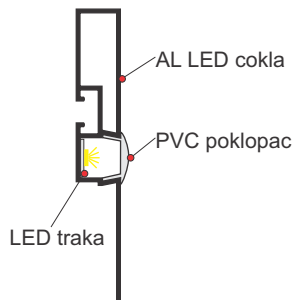
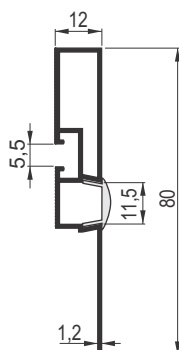

CN AL LED COKLA

Cokla za spoj kuhinjskih elemenata i poda. Za nogu elementa veže se pomoću odgovarajuće šnale.



3	mat srebro	2110	3	bela	2113
3	sjaj bela	2109	PVC poklopac		
3	sjaj crna	2111			
AL LED profil					

CN AL COKLA GLATKA

Cokla za spoj kuhinjskih elemenata i poda. Za nogu elementa veže se pomoću odgovarajuće šnale. Sve cokle na sebi imaju meki PVC profil koji naleže na pod i stvara nepropusni spoj cokle i poda.



 H = 15cm

		šifra
3	mat srebro	1765







 H = 12cm

		šifra
3	mat srebro	609



 H = 10cm

		šifra			šifra
3	mat srebro	611	4	mat srebro	5287
3	sjaj srebro	2768	4	sjaj srebro	5316

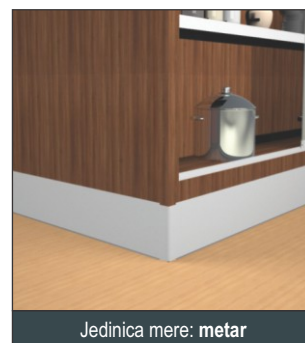

CN AL COKLA RELJEFNA

Cokla za spoj kuhinjskih elemenata i poda. Za nogu elementa veže se pomoću odgovarajuće šnale. Sve cokle na sebi imaju meki PVC profil koji naleže na pod i stvara nepropusni spoj cokle i poda.

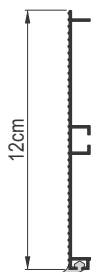

 H = 12cm

		šifra
3	mat srebro	338

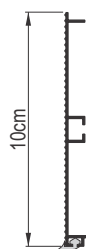

 H = 10cm

		šifra
3	mat srebro	610



 * Sve dužine su u metrima, ukoliko drugačije nije naznačeno.

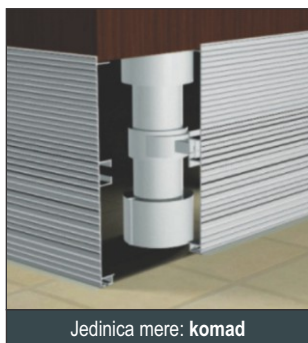

Jedinica mere: komad



CN ŠNALA ZA AL COKLU

Šnale se koriste za vezivanje cokle za predviđenu nogicu.



kom	crna	341
-----	------	-----

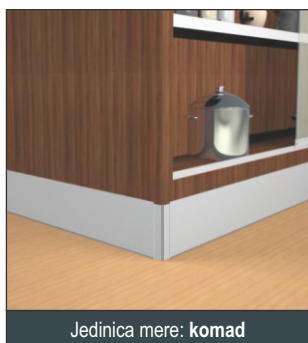

Jedinica mere: komad

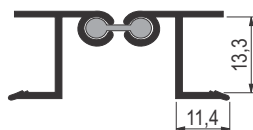

CN AL SAVITLJIVI VEZNI UGAO

Vežni ugao služi za spoj Al cokli pod različitim uglovima.



10cm	mat srebro	486
12cm	mat srebro	603
15cm	mat srebro	837

* Dužine Al savitljivog ugla izražene su u centimetrima.



Jedinica mere: komad

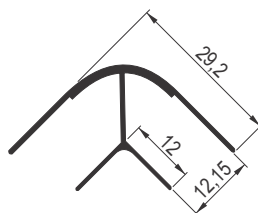

CN AL SPOLJNI I UNUTRAŠNJI UGAO

za spoj cokli pod uglom od 90° stepeni.



10cm	mat srebro	339
12cm	mat srebro	340
15cm	mat srebro	838

* Dužine Al ugla izražene su u centimetrima.



Jedinica mere: komad



AL TABLA 100 x 2000mm FLAH

Aluminijumski flah svoju primenu pronalazi u izradi nameštaja od pločastih materijala, kao i u završnim radovima u građevinarstvu. Al tabla flah je 2m dužine i prodaje se na komad.



2	mat srebro	1376
---	------------	------

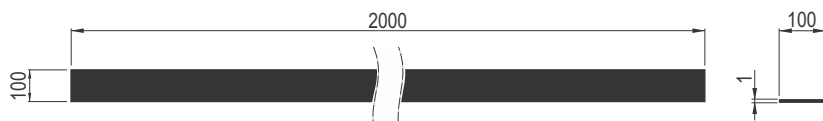

VENTILACIONE REŠETKE

- **VEN AL VENTILACIONA REŠETKA TQ 05**
(300 x 100mm - 500 x 100mm)
 - **VEN AL VENTILACIONA REŠETKA TQ 01**
(300 x 86mm - 500 x 86mm)
 - **VEN AL VENTILACIONA REŠETKA TQ 03**
(300 x 60mm - 500 x 60mm - 800 x 60mm)
 - **VEN AL VENTILACIONA REŠETKA**
(3000 x 120mm - 3000 x 70mm)
 - **VEN AL VENTILACIONA REŠETKA NA MERU**
Dublja (30mm) - Plića (19mm)
-
- **VEN PVC VENTILACIONA REŠETKA**
430 x 76mm



europofill

 * Sve dužine su u metrima, ukoliko drugačije nije naznačeno.

VEN AL VENTILACIONA REŠETKA TQ 05

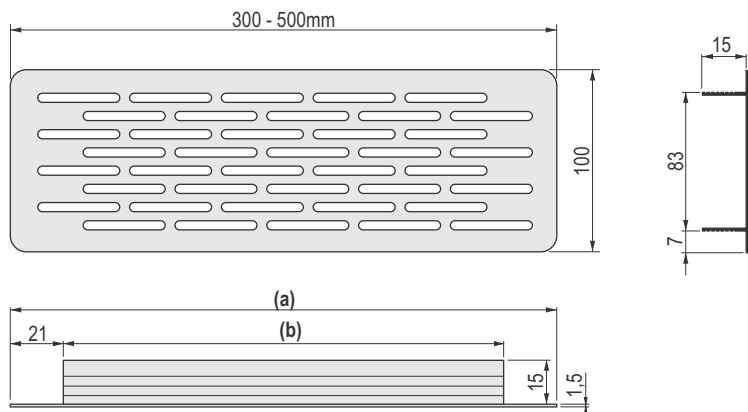
(300 x 100mm - 500 x 100mm)





			šifra	(a)	(b)
300 x 100	mat srebro		2396	300	258
500 x 100	mat srebro		2397	500	458

* Dužine Al ventilacionih rešetki TQ 05 izražene su u milimetrima.

VEN AL VENTILACIONA REŠETKA TQ 01

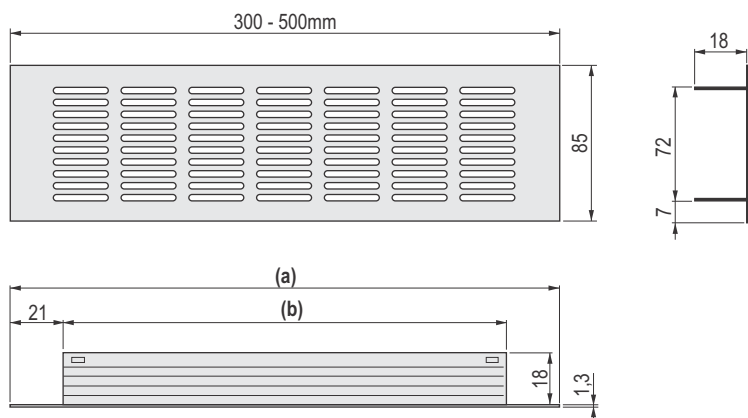
(300 x 85mm - 500 x 85mm)





			šifra	(a)	(b)
300 x 85	mat srebro		2394	300	258
500 x 85	mat srebro		2395	500	458

* Dužine Al ventilacionih rešetki TQ 01 izražene su u milimetrima.

VEN AL VENTILACIONA REŠETKA TQ 03

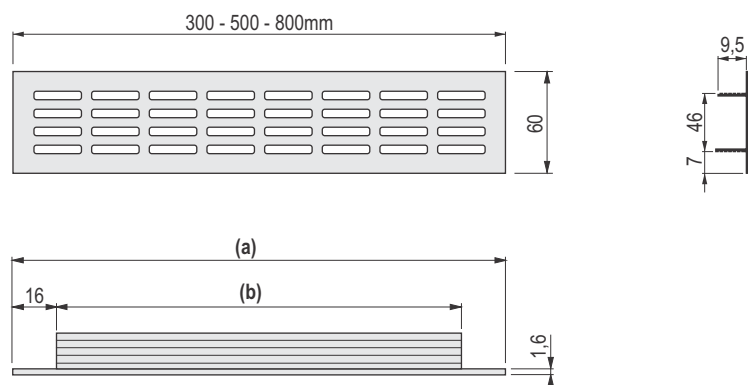
(300 x 60mm - 500 x 60mm - 800 x 60mm)



			šifra	(a)	(b)
300 x 60	mat srebro		2833	300	268
500 x 60	mat srebro		2834	500	468
800 x 60	mat srebro		2835	800	768

* Dužine Al ventilacionih rešetki TQ 03 izražene su u milimetrima.

 * Sve dužine su u metrima, ukoliko drugačije nije naznačeno.

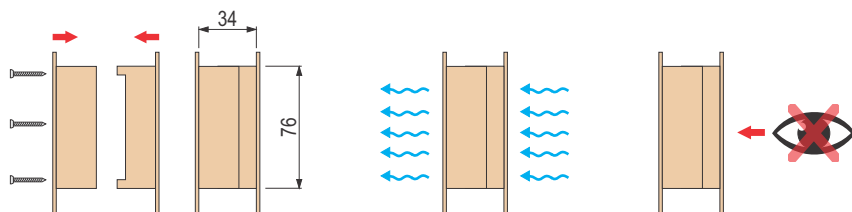
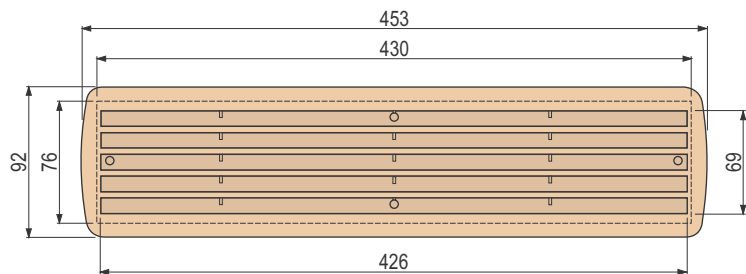

VEN PVC VENTILACIONE REŠETKE 430 x 76mm

PVC ventilacione rešetke dolaze u paru, jedan deo je za unutrašnju stranu vrata, a drugi deo za spoljašnju stranu vrata. PVC dekorativne ventilacione rešetke dostupne su u tri boje: bela, hrast, siva.



453	bela	6281
453	bež	6282
453	siva	6280
Jedinica mere: par		

* Dužine PVC ventilacionih rešetki izražene su u milimetrima.

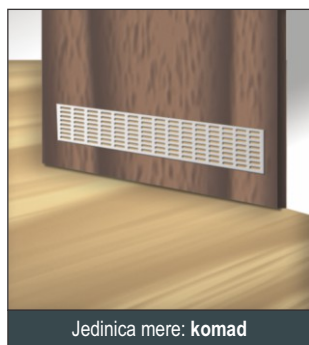

Jedinica mere: komad



S = 120mm / S = 70mm

VEN AL DEKORATIVNE VENTILACIONE REŠETKE

Aluminijumske dekorativne ventilacione rešetke rade se u širinama: 70mm i 120mm. Prodaju se isključivo kao cele šipke dužine 3m.



3	mat srebro	707	S = 120
3	mat srebro	706	S = 70

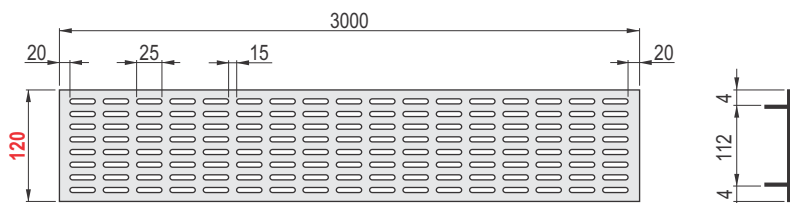

AL VENTILACIONA REŠETKA S = 120

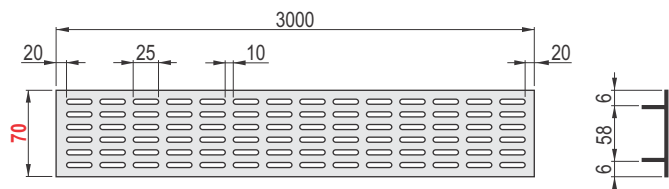

AL VENTILACIONA REŠETKA S = 70

VEN VENTILACIONA REŠETKA NA MERU - Dublja (30mm)

Ventilaciona rešetka dubine 30mm radi se isključivo po meri, na zahtev kupca. **Rok izrade je 5 do 7 dana!**

Ventilaciona rešetka omogućava nesmetano strujanje vazduha, dok iskošeni oblik aluminijumskih lamela smanjuje mogućnost vidljivosti kroz Al rešetku. Završna obrada ventilacione rešetke je mat srebrno eloksaža.

Ventilacione rešetke izrađujemo u sledećim dimenzijama (min. / max):

Dužina (200mm / 1000mm), Visina: (100mm / 1000mm).

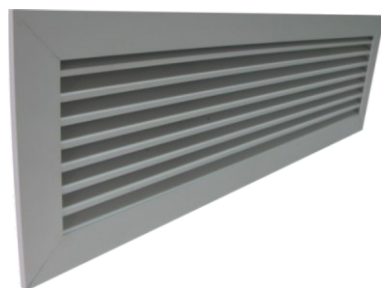

elementi	šifra
Al ram	958
Al lamela	960
Al distancer	5534
Al vertikala	418
metalni ugao	980

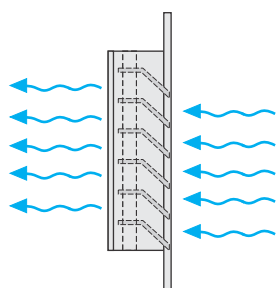
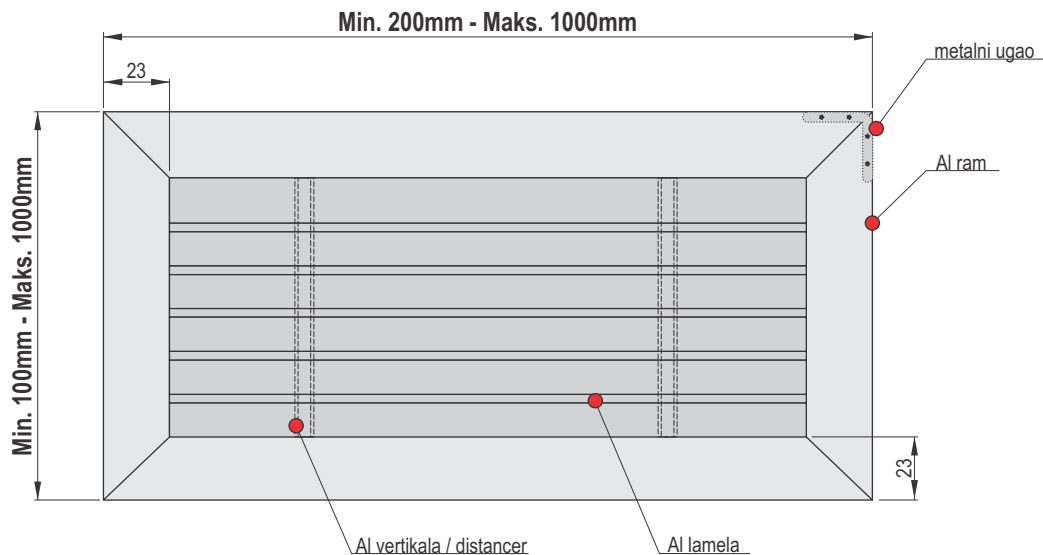
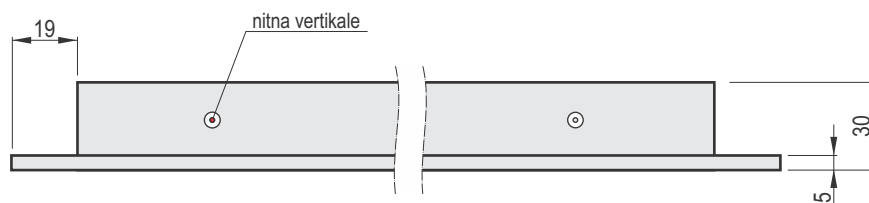

Nesmetano kretanje vazduha

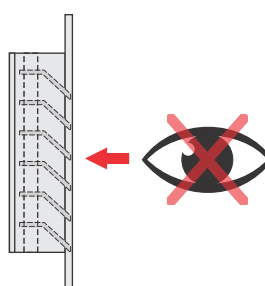

Smanjena vidljivost kroz Al rešetku

VEN VENTILACIONA REŠETKA NA MERU - Plića (19mm)

Ventilaciona rešetka dubine 19mm radi se isključivo po meri, na zahtev kupca. **Rok izrade je 5 do 7 dana!**

Zbog lamela manjih dimenzija, plića ventilaciona rešetka je skroz providna, što omogućava konstantni prolaz velike količine vazduha. Završna obrada ventilacione rešetke je mat srebrno eloksaža.

Ventilacione rešetke izrađujemo u sledećim dimenzijama (min./max):

Dužina (200mm / 1000mm), Visina: (100mm / 1000mm).

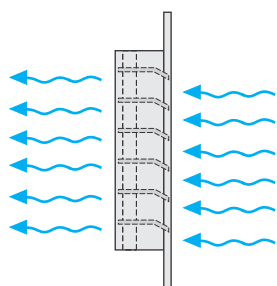
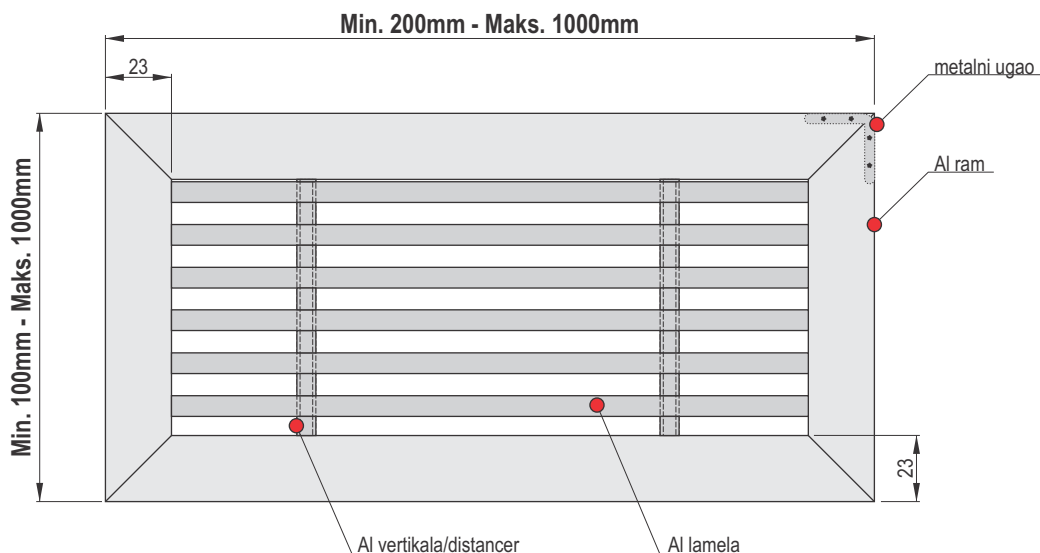
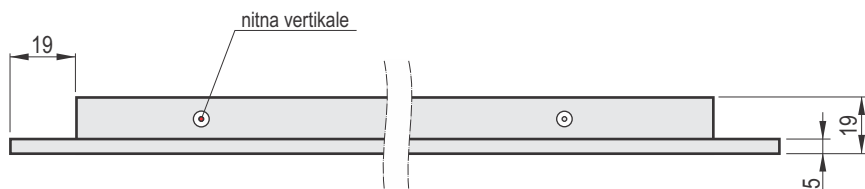
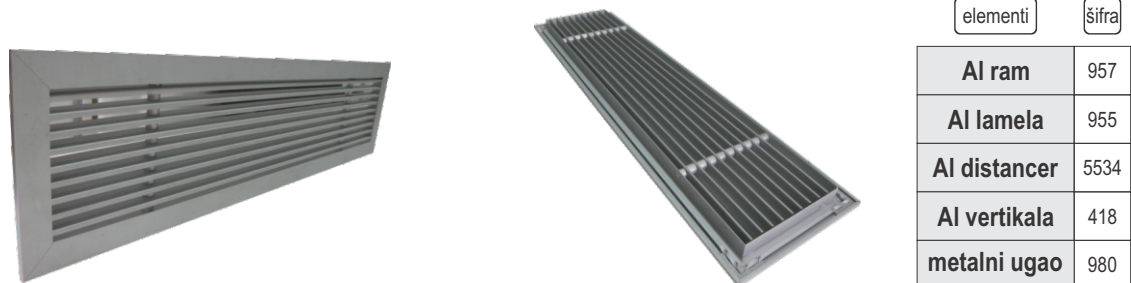

Nesmetano kretanje vazduha

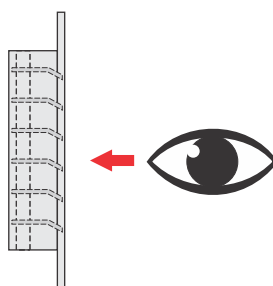

Providna Al rešetka

DP DIHT PROFILI ZA RADNE PLOČE



europrofil

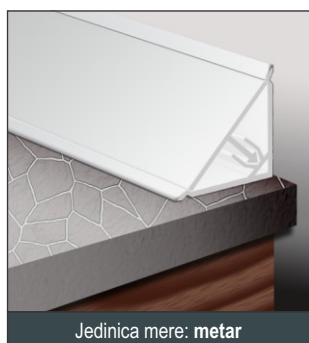

Jedinica mere: metar

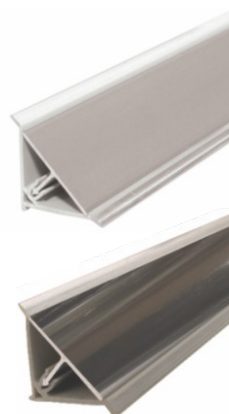
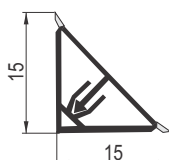

DP MINI K1 DIHT AL PROFIL

Profil za spoj zida i radne ploče.
K1 Mini je model sa glatkom Al površinom, dimenzije 15 x 15mm. Za ovaj model postoje odgovarajući setovi uglova i završetaka.



4	mat srebro	4316	set	mat srebro	4381
4	sjaj srebro	4715	set	sjaj srebro	4723
K1 Mini			set - elementi		



Set elementi - Spoljašnji ugao, unutrašnji ugao i čepovi

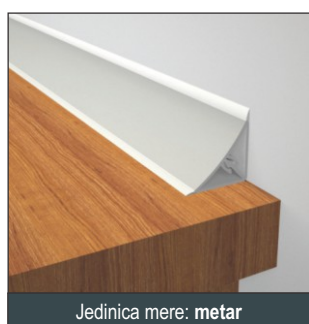

Jedinica mere: metar

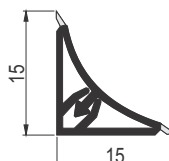

DP MINI DIHT AL PROFIL / PR

Profil za spoj zida i radne ploče.
Al Mini PR je model sa glatkom Al površinom, dimenzije 15 x 15mm. Za ovaj model postoje odgovarajući setovi uglova i završetaka.



4	mat srebro	4318	set	mat srebro	4380
4	sjaj srebro	4714	set	sjaj srebro	4722
Mini / PR			set - elementi		



Set elementi - Spoljašnji ugao, unutrašnji ugao i čepovi

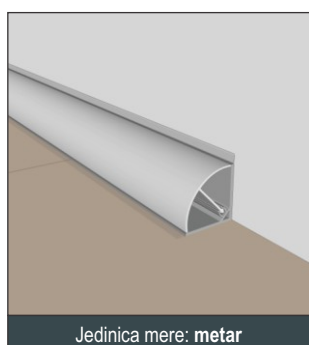

Jedinica mere: metar

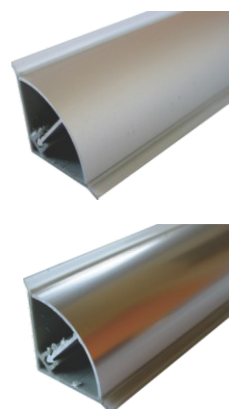
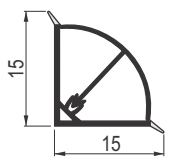

DP MINI K9 DIHT AL PROFIL

Profil za spoj radne ploče i zida.
K9 Mini je model sa glatkom aluminijumskom površinom, dimenzije 15 x 15mm. Za ovaj model postoje odgovarajući setovi uglova i završetaka.



4	mat srebro	4317	set	mat srebro	4382
4	sjaj srebro	4716	set	sjaj srebro	4724
K9 Mini			set - elementi		



Set elementi - Spoljašnji ugao, unutrašnji ugao i čepovi



Jedinica mere: metar

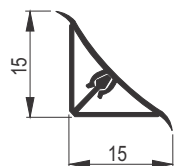

DP 15 x 15 DIHT PVC PROFIL

Profil za spoj radne ploče i zida, dimenzije 15 x 15mm. Izrađuje se u PVC osnovi sa PVC folijom. Za ovaj model postoje odgovarajući setovi uglova i završetka.



3,6	mat srebro	1557	set	mat srebro	6880
3,6	bela	627	set	bela	6881
15 x 15			set - elementi		



Set elementi - Spoljašnji ugao, unutrašnji ugao i čepovi

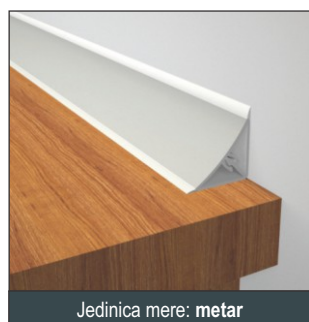

Jedinica mere: metar

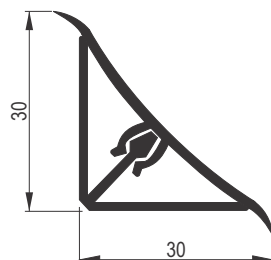

DP 30 x 30 DIHT PVC PROFIL

Profil za spoj radne ploče i zida, dimenzije 30 x 30mm. Izrađuje se u PVC osnovi sa folijom. Za ovaj model postoje odgovarajući setovi uglova i završetka.



4	mat srebro	1556	set	mat srebro	2420
4	sjaj srebro	1766	set	sjaj srebro	2750
4	inox srebro	1767	set	bela	2751
4	sjaj bela	2807	set - elementi		
4	mat bela	5552			
30 x 30					



mat srebro

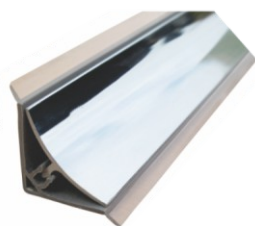

sjaj srebro



inox srebro



sjaj bela



mat bela

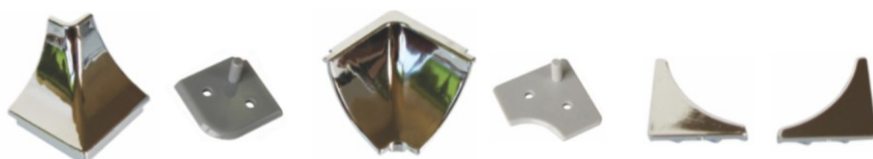

Set elementi - Spoljašnji ugao, unutrašnji ugao i čepovi

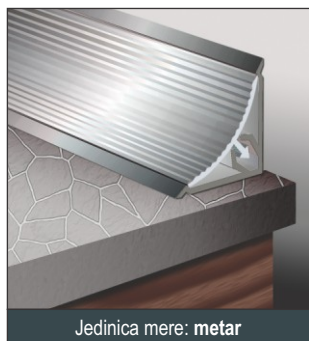

Jedinica mere: metar

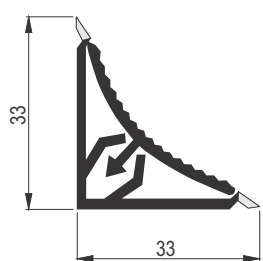

DP 30 x 30 reljefni / R

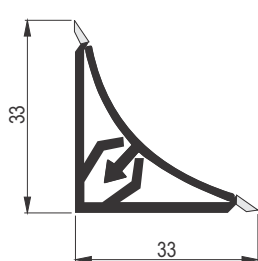

DP 30 x 30 glatki / PR

DP 30 x 30 DIHT AL PROFIL / PR
DP 30 x 30 DIHT AL PROFIL / R

Profil za spoj radne ploče i zida, dimenzije 33 x 33mm. Izrađuje se u glatkoj i rebrastoj varijanti. Za ovaj model postoje odgovarajući setovi uglova i završetka.



4	mat srebro	279	30 x 30 / R
4	mat srebro	1770	30 x 30 / PR
set	mat srebro	2581	set - elementi



DP 30 x 30 reljefni / R



DP 30 x 30 glatki / PR



Set elementi - Spoljašnji ugao, unutrašnji ugao i čepovi

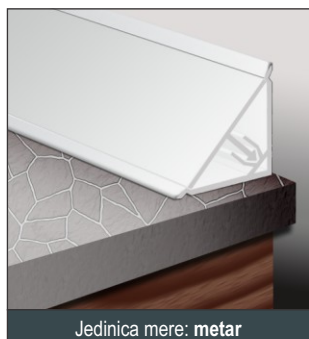

Jedinica mere: metar

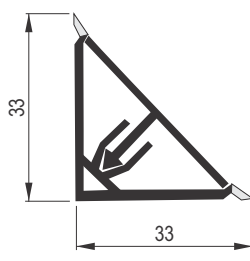

DP K1 glatki

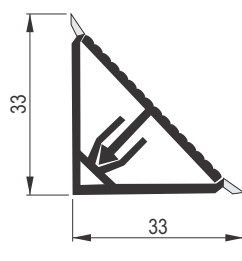

DP K2 rebrasti

DP K1 DIHT AL PROFIL
DP K2 DIHT AL PROFIL

Profil za spoj radne ploče i zida, dimenzije 33 x 33mm. Izrađuje se u glatkoj i rebrastoj varijanti.

K1 je model sa glatkom Al površinom. K2 je model sa reljefnom površinom i mat obradom.

Za ove modele postoje odgovarajući setovi uglova i završetka.



4	mat srebro	713	K1
4	sjaj srebro	719	K1
4	mat srebro	714	K2
set	mat srebro	2367	set - elementi
set	sjaj srebro	2475	



DP K1 mat

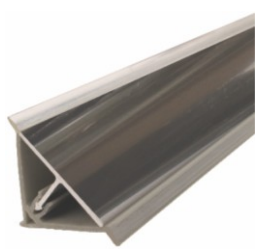

DP K1 sjaj



DP K2 mat rebrasti

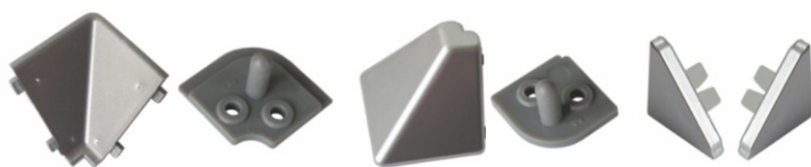

Set elementi - Spoljašnji ugao, unutrašnji ugao i čepovi

* Sve dužine su u metrima, ukoliko drugačije nije naznačeno.

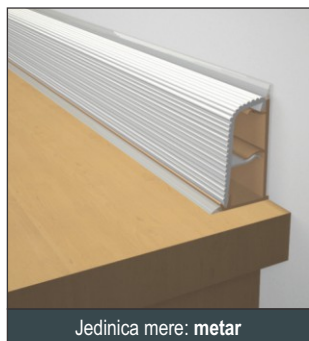

Jedinica mere: metar

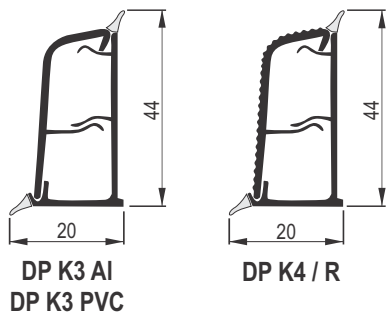

DP K3 AI
DP K3 PVC

DP K4 / R

**DP K3 / DP K4 AI DIHT PROFILI
DP K3 PVC - Al folija**

Profili za spoj radne ploče i zida, dimenzije 20 x 44mm.

K3 je model sa glatkom Al površinom.

K4 je model sa reljefnom Al površinom i mat obradom. Za ove modele postoje odgovarajući setovi uglova i završetka.

				šifra					
4	mat srebro	715	K3 AL	set	mat srebro	2368	set - elementi		
4	sjaj srebro	717	K3 AL	set	sjaj srebro	2474			
4	Al folija brušena	4587	K3 PVC						
4	Al folija inox	2077	K3 PVC						
4	mat srebro	716	K4 / R						



Set elementi - Spoljašnji ugao, unutrašnji ugao i čepovi



DP K3 AI mat

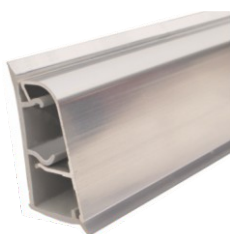

DP K3 AI sjaj



DP K4 AI mat reljefna

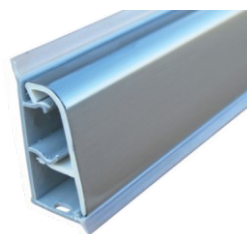

DP K3 PVC
Al folija inox



DP K3 PVC
Al folija brušena

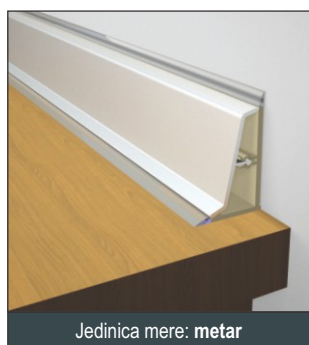

Jedinica mere: metar

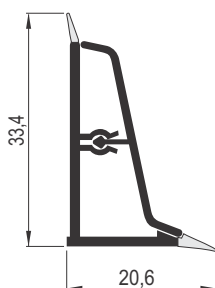

DP K7 DIHT PROFIL

Profil za spoj radne ploče i zida, dimenzije 20 x 33mm. K7 je model sa glatkom Al površinom i ima odgovarajuće setove uglova i završetka.

				šifra				
4	mat srebro	1876	set	mat srebro	2472	set - elementi		
4	sjaj srebro	1877	set	sjaj srebro	2529			
K7								



DP K7 AI
mat srebro



DP K7 AI
sjaj srebro

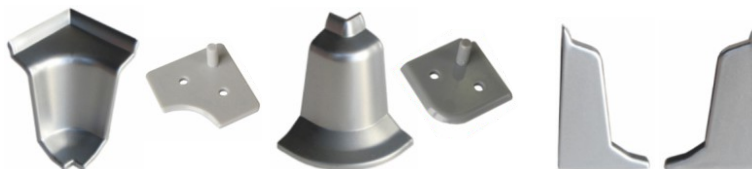

Set elementi - Spoljašnji ugao, unutrašnji ugao i čepovi

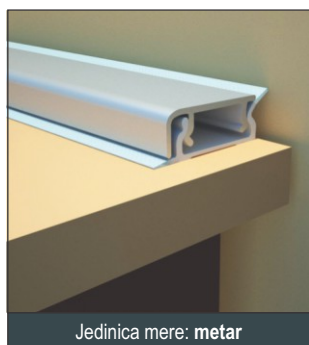

Jedinica mere: metar

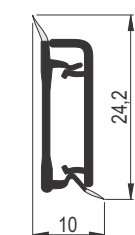

Vertikalno postavljanje

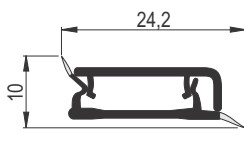

Horizontalno postavljanje

DP K5 AI DIHT PROFIL DP K5 PVC - Al folija

Profil za spoj radne ploče i zida. K5 je model sa glatkom Al površinom. Može se postavljati i vertikalno. Profili imaju odgovarajuće horizontalne i vertikalne setove uglova i završetka.



4	mat srebro	1519	K5 AL	set	mat srebro	2369	set elementi
4	sjaj srebro	1636	K5 AL	set	sjaj srebro	2473	
4	bela	575	K5 AL	set	bela	577	
4	Al folija brušena	2496	K5 PVC	horizontalno postavljanje			
4	Al folija inox	4391	K5 PVC	set	mat srebro	4749	set elementi
				set	sjaj srebro	4750	
vertikalno postavljanje							

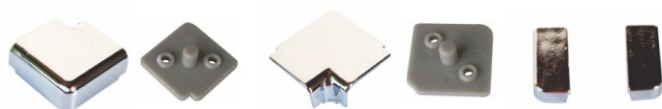

Set elementi - Spoljašnji ugao, unutrašnji ugao i čepovi - Horizontalni



DP K5 AI mat srebro

DP K5 AI sjaj srebro

DP K5 AI sjaj bela

DP K5 PVC Al folija inox

DP K5 PVC Al folija brušena

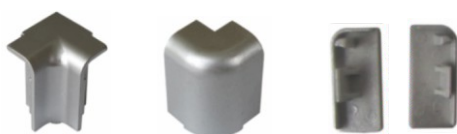

Set elementi - Spoljašnji ugao, unutrašnji ugao i čepovi - Vertikalni

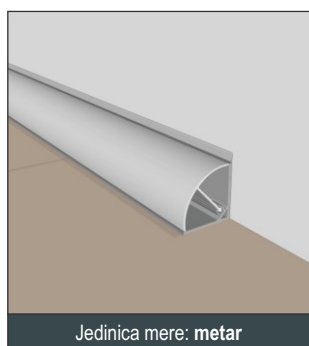
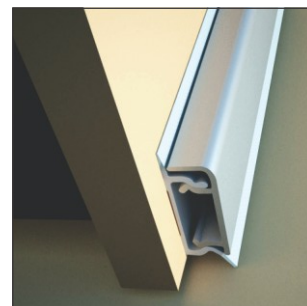

Jedinica mere: metar

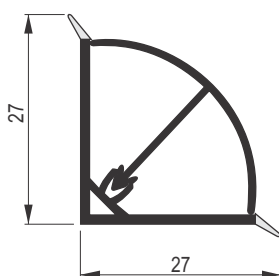

DP K9 DIHT PROFIL

Profil za spoj radne ploče i zida, dimenzije 27 x 27mm. K9 je model sa glatkom aluminijumskom površinom. Za ovaj model postoje odgovarajući setovi uglova i završetka.



4	mat srebro	2518	set	mat srebro	2530
4	sjaj srebro	2519	set	sjaj srebro	2531
K9			set - elementi		

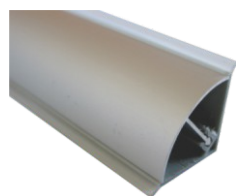

DP K9 AI mat srebro

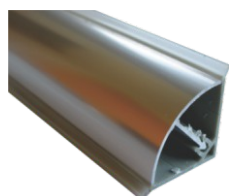

DP K9 AI sjaj srebro

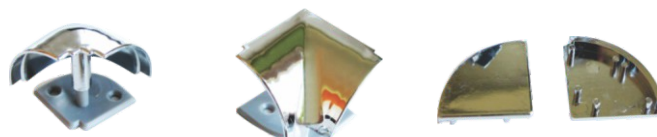

Set elementi - Spoljašnji ugao, unutrašnji ugao i čepovi

T VEZNI PROFILI ZA RADNE PLOČE



europrofil

T - 01

Profil za spoj radnih ploča debljine 30mm, pod uglom od 90°. Profil T - 01 namenjen je za radne ploče sa radijusom 6mm.



63	mat srebro	280
----	------------	-----

* Dužina profila T - 01 izražena je u centimetrima.

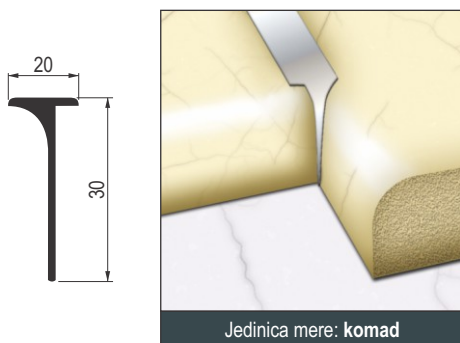

T - 09

Profil za spoj radnih ploča, debljine 40mm, pod uglom od 90°. Profil T - 09 namenjen je za radne ploče sa radijusom 3mm.



63	mat srebro	288
----	------------	-----

* Dužina profila T - 09 izražena je u centimetrima.

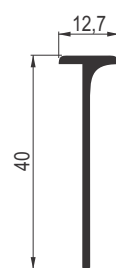

T - 02

Profil za završetak radnih ploča, debljine 30mm. Površina profila je reljefna. Profil T - 02 namenjen je za radne ploče sa radijusom 6mm.



64	mat srebro	526
----	------------	-----

* Dužina profila T - 02 izražena je u centimetrima.

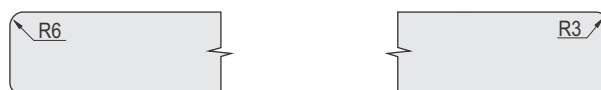
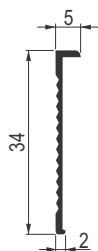

T - 10

Profil za završetak radnih ploča, debljine 40mm. Profil T - 10 namenjen je za radne ploče sa radijusom 3mm. Površina profila je glatka.



64	mat srebro	876
----	------------	-----

* Dužina profila T - 10 izražena je u centimetrima.

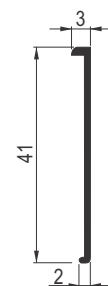

T - 03

Profil za spoj radnih ploča debljine 30mm u istoj ravni. Profil T - 03 namenjen je za radne ploče sa radijusom 6mm.



63	mat srebro	282
----	------------	-----

* Dužina profila T - 03 izražena je u centimetrima.

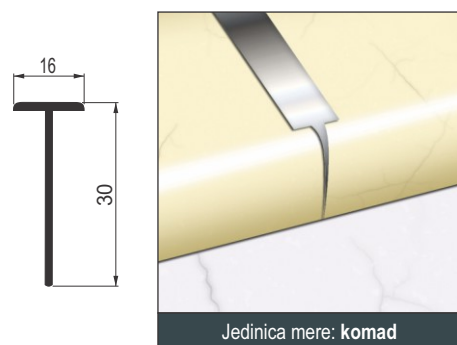

T - 08

Profil za spoj radnih ploča debljine 40mm u istoj ravni. Profil T - 08 namenjen je za radne ploče sa radijusom 3mm.



63	mat srebro	725
----	------------	-----

* Dužina profila T - 08 izražena je u centimetrima.

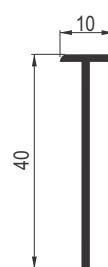

T - 11

Profil za završetak radnih ploča, debljine 60mm. Profil T - 11 namenjen je za radne ploče sa radijusom 6mm.



67	mat srebro	1923
----	------------	------

* Dužina profila T - 11 izražena je u centimetrima.

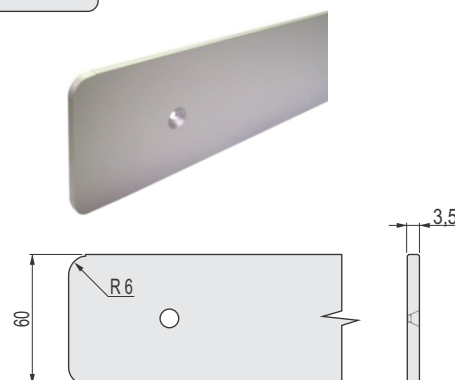

T 01 - EP

Profil za spoj radnih ploča debljine do 30mm, pod uglom od 90°. Profil je namenjen za radne ploče sa radijusom 6mm.

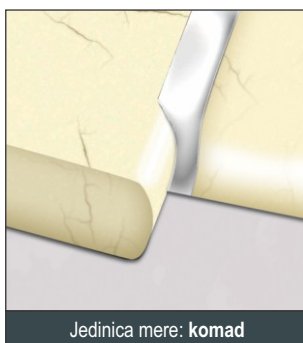
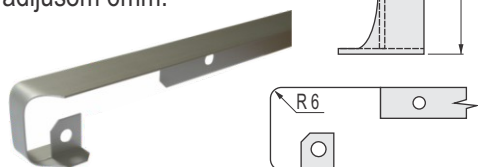

67	mat srebro	2829	67	sjaj srebro	2832
----	------------	------	----	-------------	------

* Dužina profila T 01 - EP izražena je u centimetrima.

T 09 - EP

Profil za spoj radnih ploča debljine do 40mm, pod uglom od 90°. Profil je namenjen za radne ploče sa radijusom 3mm.

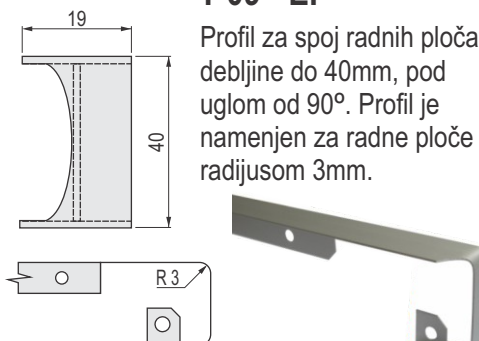

63	mat srebro	2823	63	sjaj srebro	2826
----	------------	------	----	-------------	------

* Dužina profila T 09 - EP izražena je u centimetrima.

T 02 - EP

Profil za završetak radnih ploča, debljine do 30mm. Profil je namenjen za radne ploče sa radijusom 6mm.



67	mat srebro	2827	67	sjaj srebro	2830
----	------------	------	----	-------------	------

* Dužina profila T 02 - EP izražena je u centimetrima.

T 10 - EP

Profil za završetak radnih ploča, debljine do 40mm. Profil je namenjen za radne ploče sa radijusom 3mm.

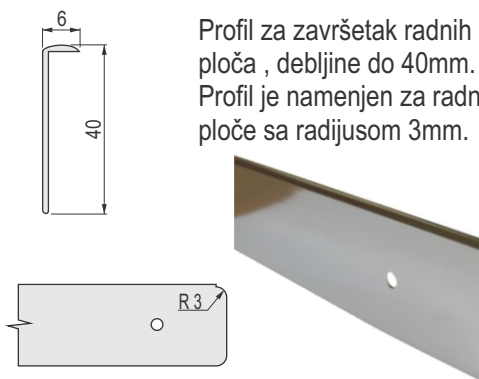

67	mat srebro	2821	67	sjaj srebro	2824
----	------------	------	----	-------------	------

* Dužina profila T 10 - EP izražena je u centimetrima.

T 03 - EP

Profil za spoj radnih ploča u istoj ravni, debljine do 30mm. Profil je namenjen za radne ploče sa radijusom 6mm.

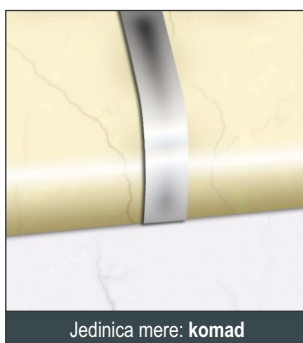
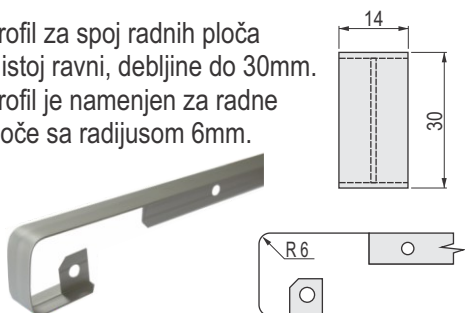

67	mat srebro	2828	67	sjaj srebro	2831
----	------------	------	----	-------------	------

* Dužina profila T 03 - EP izražena je u centimetrima.

T 08 - EP

Profil za spoj radnih ploča u istoj ravni, debljine do 40mm. Profil je namenjen za radne ploče sa radijusom 3mm.

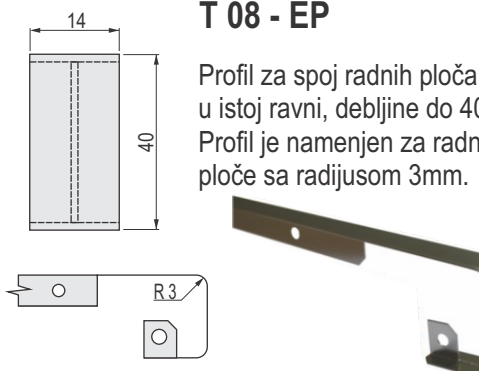

67	mat srebro	2822	67	sjaj srebro	2825
----	------------	------	----	-------------	------

* Dužina profila T 08 - EP izražena je u centimetrima.



- UP GARDEROBNA ŠIPKA OVALNA - GLATKA
- UP GARDEROBNA ŠIPKA OVALNA - REBRATA
- UP NOSAČI GARDEROBNIH ŠIPKI
- UP LED GARDEROBNA ŠIPKA - SENZOR POKRETA

 * Sve dužine su u metrima, ukoliko drugačije nije naznačeno.

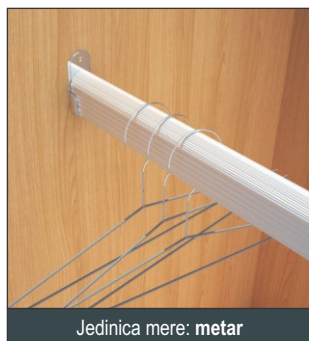

Jedinica mere: metar

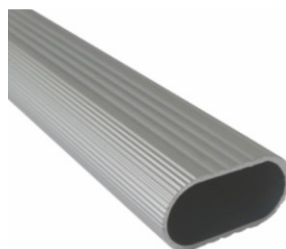
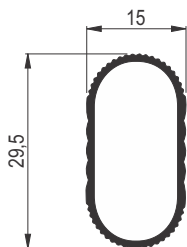

UP GARDEROBNA ŠIPKA OVALNA REBRATA

Aluminijumska ovalna rebrasta oklagija, koristi se kao garderobna šipka za unutrašnje uređenje plakara.



6	mat srebro	445
---	------------	-----

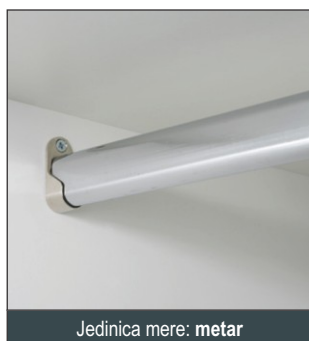

Jedinica mere: metar

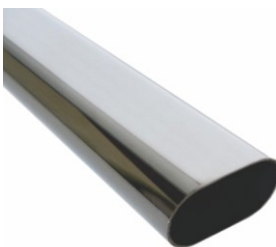
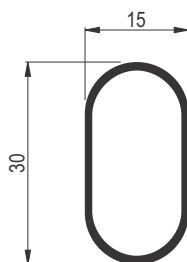

UP GARDEROBNA ŠIPKA OVALNA - GLATKA

Aluminijumska ovalna glatka oklagija, koristi se kao garderobna šipka za unutrašnjost plakara.



3	mat srebro	4052
---	------------	------

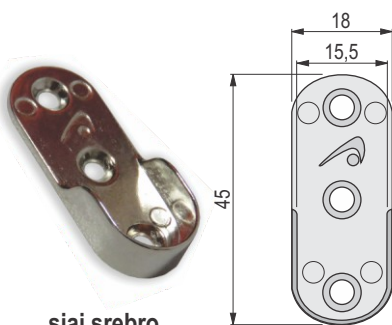

sjaj srebro

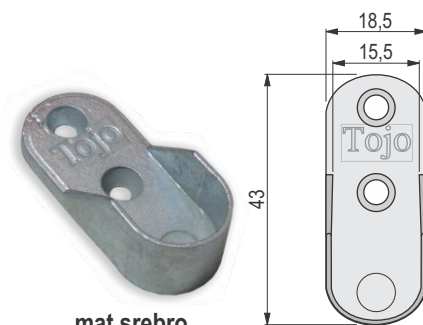

mat srebro

UP NOSAČ OKLAGIJE - BOČNI

Aluminijumski bočni nosač oklagije.



kom	mat srebro	1890
kom	sjaj srebro	5280



Jedinica mere: komad

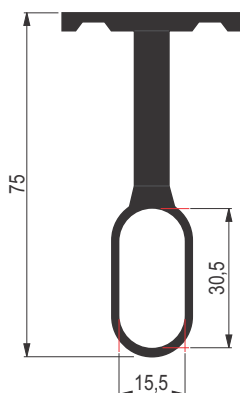

UP NOSAČ OKLAGIJE - VISEĆI

Viseći aluminijumski nosač garderobne šipke - oklagije. U ponudi imamo zatvoren i otvoren Al nosač.



kom	srebro	2182	zatvoren
kom	srebro	2183	otvoren



Jedinica mere: komad

UP LED garderobna šipka - Senzor pokreta

UP LED garderobna šipka prodaje se na komad. Delovi UP LED garderobne šipke su:
 + LED profil (garderobna šipka) u srebo mat završnoj obradi sa neutralnom LED trakom (4000 - 4400 K).

+ Alkalne baterije DC - 1,5V za LED garderobnu šipku.

UP LED garderobna šipka na sebi sadrži senzor pokreta, kao i fizički prekidač.

Dostupne dužine UP LED garderobnih cevi kreću se od: 45cm do 120cm.

Svaku LED garderobnu šipku, moguće je skratiti za maksimalno 5cm. LED traku unutar garderobne šipke, obavezno seći samo na spojevima, u suprotnom LED traka neće raditi.

Šifra	Šifra	Šifra	Šifra	Šifra	Šifra	Šifra	Šifra	Šifra	Šifra	Šifra	Šifra	Šifra		
45	mat srebo	4666	65	mat srebo	4670	85	mat srebo	4674	105	mat srebo	6337	kom	mat srebo	1890
50	mat srebo	4667	70	mat srebo	4671	90	mat srebo	4675	110	mat srebo	6338	kom	sjaj srebo	5280
55	mat srebo	4668	75	mat srebo	4672	95	mat srebo	4676	115	mat srebo	4678	Nosaci garderobnih šipki		
60	mat srebo	4669	80	mat srebo	4673	100	mat srebo	4677	120	mat srebo	4679			

* Dužina UP LED garderobnih šipki izražena je u centimetrima.

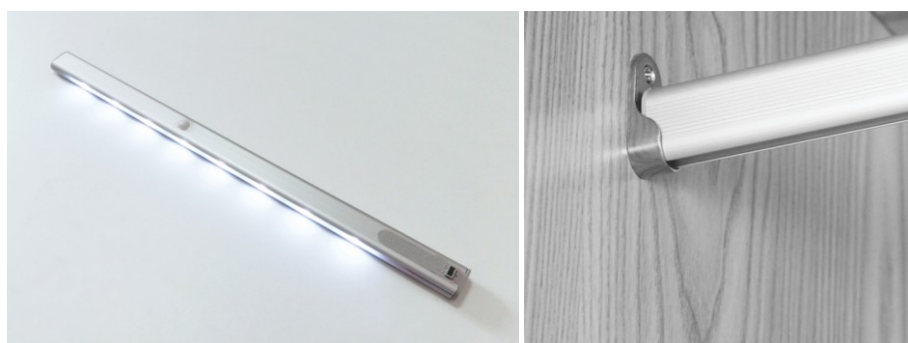
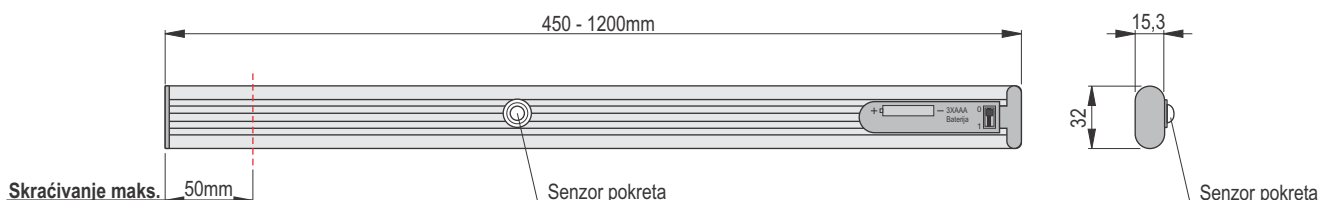

Skraćivanje - UP LED garderobne šipke

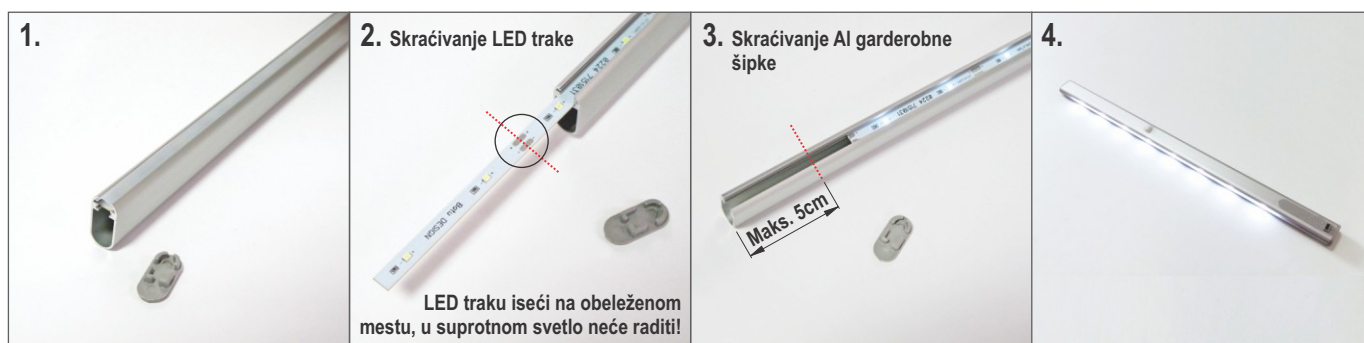



Jedinica mere: komad

UP E LED garderobna šipka - Senzor pokreta

UP E LED garderobna šipka se prodaje na komad zajedno sa svim elementima za montažu.

Elementi koji dolaze uz garderobnu šipku:

- + LED profil (garderobna šipka) u choco i antracit završnoj obradi, sa neutralno belom LED trakom (4000 - 4400K).
- + Nosači šipke i dekorativni poklopci u choco boji.
- + Šrafovi za montažu i alkalne baterije (DC - 9V) za LED garderobnu šipku.

Dostupne dužine UP E LED garderobne šipke: 40cm, 50cm, 60cm, 70cm, 80cm, 90cm, 100cm, 110cm i 120cm.

UP E LED garderobna šipka na sebi sadrži senzor pokreta.
LED garderobnu šipku je moguće montirati i na adapter od DC - 12V.

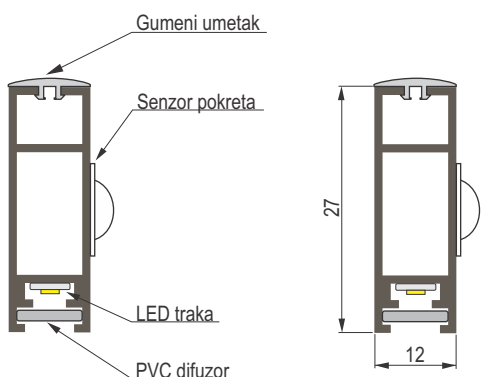

Šifra	Šifra	Šifra	Šifra	Šifra	Šifra	Šifra	Šifra	Šifra	Šifra		
40	choco	5477	90	choco	5482	40	antracit	2371	90	antracit	644
50	choco	5478	100	choco	5483	50	antracit	2344	100	antracit	2004
60	choco	5479	110	choco	5484	60	antracit	915	110	antracit	552
70	choco	5480	120	choco	5485	70	antracit	1586	120	antracit	252
80	choco	5481				80	antracit	643			

* Dužina UP LED garderobnih šipki izražena je u centimetrima.

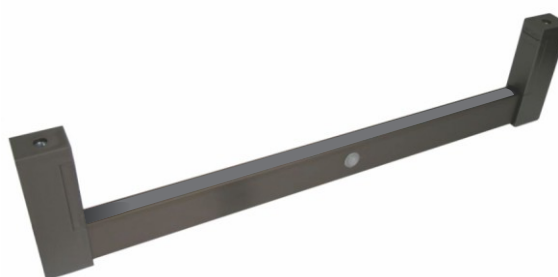
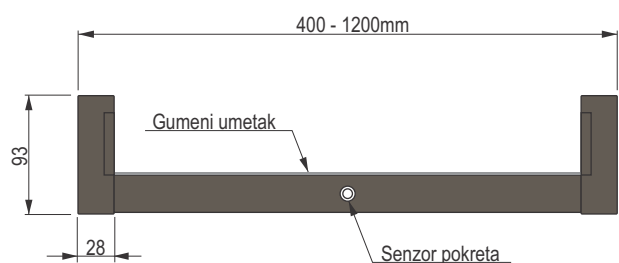

UP E LED garderobna šipka - Choco

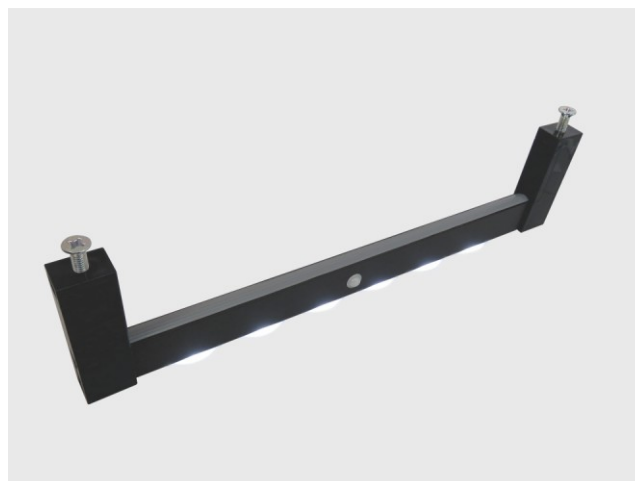
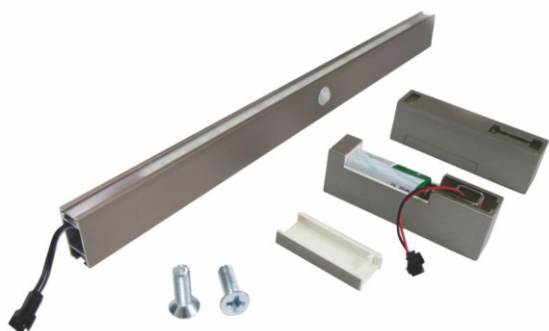

UP E LED garderobna šipka - Antracit

AL RAMOVI I PROFILI ZA IZRADU FRONTA

- RAM ALUMINIJUMSKI RAMOVI
- RAM DODATNI ELEMENTI ZA IZRADU AL RAMOVA
- ALUMINIJUMSKI PROFILI ZA IZRADU PANELA

europofil

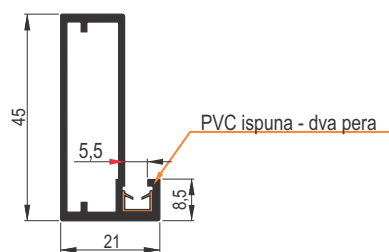

RAM 1002 A

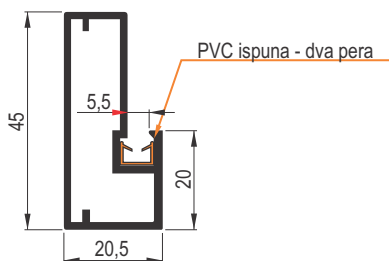

Profil za izradu fronta.
Dimenzija stakla umanjuje se za 6mm od ukupne dimenzije rama.

		šifra			šifra
6	mat srebro	1798	5 i 5,5	bronz brušena	2932
5 i 5,5	sjaj srebro	1654	6	mat choco	5706
5 i 5,5	sjaj srebro brušeno	4755	6	sjaj crna	5707
			6	mat crna	7077



RAM 1002 D

Profil za izradu fronta.
Dimenzija stakla umanjuje se za 28mm od ukupne dimenzije rama.

		šifra			šifra
6	mat srebro	1650	5	bronz brušena	2934
5	sjaj srebro	1651	6	mat choco	5708
5	sjaj srebro brušeno	4905	6	mat crna	6953

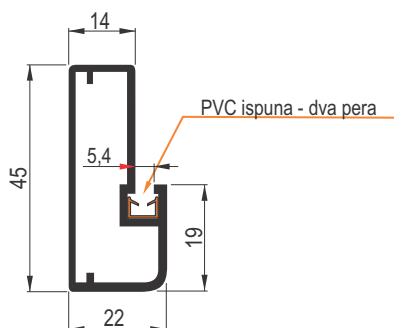

RAM 1002 C

Profil za izradu fronta. Dimenzija stakla umanjuje se za 28mm od ukupne dimenzije rama.

		šifra
6	mat srebro	1681

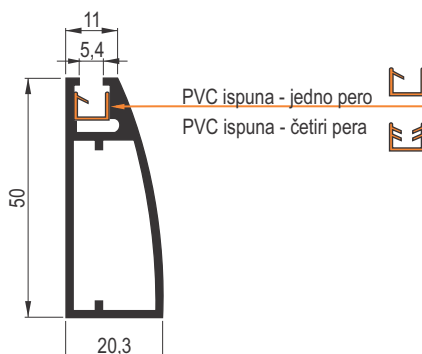

RAM 1001



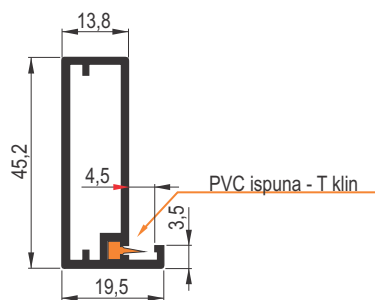

Profil za izradu fronta.
Dimenzija stakla umanjuje se za 89mm od ukupne dimenzije rama.

		šifra
6	mat srebro	1680



RAM 1002 N

Profil za izradu fronta.
Dimenzija stakla umanjuje se za 3mm od ukupne dimenzije rama.

		šifra			šifra
6	mat srebro	2841	5,5	bronz brušena	2933
5 i 5,5	sjaj srebro	3871	6	mat crna	6952
5	sjaj srebro brušeno	4904			

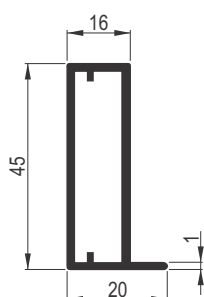
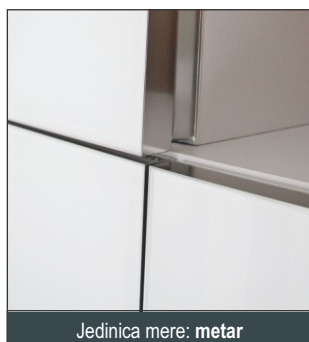

RAM 1003 N

Profil za izradu fronta.
Dimenzija stakla umanjuje se za 2mm od ukupne dimenzije rama. Specifičnost profila je da se staklo lepi za Al ram. Iz tog razloga ne bi trebalo koristiti providna stakla.

		šifra
6	mat srebro	1652
5 i 5,5	sjaj srebro	1653
5 i 5,5	bronz brušena	2796

* Pre ugradnje neophodna je obrada ivica stakla!



RAM 1004 N

Profil za izradu fronta.
Dimenzija stakla se ne umanjuje od ukupne dimenzije rama. Al ram profil 1004 N specifičan je po tome što se staklo lepi za aluminijumski ram. Iz tog razloga ne bi trebalo koristiti providna stakla.

		šifra
6	mat srebro	2393
5	sjaj srebro	7001
6	mat crna	6951

* Pre ugradnje neophodna je obrada ivica stakla!

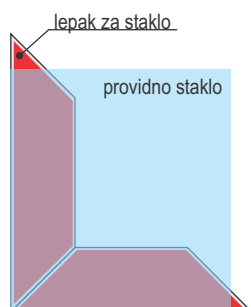

Preporučena stakla kod izrade Al ramova 1003 N i 1004 N su: ogledala, lakobel stakla i stakla sa folijom u boji.

Providna stakla se ne koriste, kako se lepak ne bi video kroz staklo, kao na primeru sa slike.

Lepkovi su neutralni i ne nagrízaju foliju.



Jedinica mere: metar

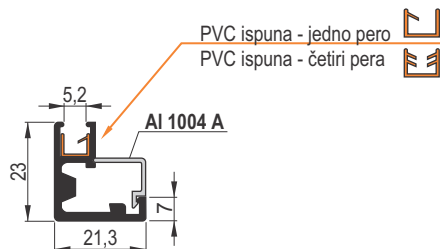

RAM 1005 A

Profil za izradu fronta.
Dimenzije stakla umanjuju se za 34mm od ukupne dimenzije rama.

		šifra			šifra
6	mat srebro	1657	6	mat srebro	1659
6	sjaj srebro	1658	6	sjaj srebro	1660
Al ram 1005 A			Al poklopac 1004 A		



Jedinica mere: metar

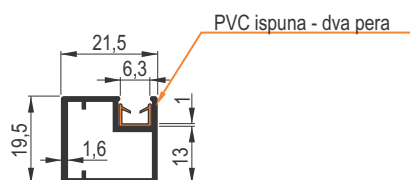

RAM 1007

Profil za izradu fronta.
Dimenzija stakla umanjuje se za 30 mm od ukupne dimenzije rama.
Šarke se ukopavaju u Al profil.

		šifra			šifra
6	mat srebro	5089	6	mat crna	6954
5,5	brušena bronza	5275	6	chocco	7002
5,5	sjaj srebro	5276			

F - AL PROFILI ZA FRONT

Materijal nije potrebno falcovati!

Aluminijumski i PVC profili koriste se za izradu rama sa staklenom ispunom, u kombinaciji sa ivericom. Od dodatnih elemenata F - Al profil sadrži uglove koji se prodaju nezavisno od samog profila. Al i PVC profili imaju obostrano lepljivu traku i lepe se za front. Nije potrebna dodatna obrada materijala.

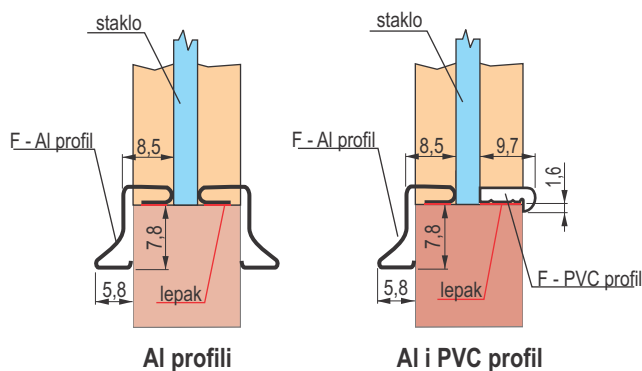

3	mat srebro	2190
3	sjaj srebro	2191
3	inox	2192

F - Al profil za front

Jedinica mere: komad



3	mat srebro	2193
---	------------	------

F - PVC profil za front

Jedinica mere: komad



kom	mat - srebro inox - srebro	2194
kom	sjaj srebro	2195

F - PVC ugao za front

Jedinica mere: komad

Dodatni elementi za izradu Al ramova:



kom	srebro	124
Metalni ugao RAM 1002 A, 1002 D, 1002 C, 1003 N, 1002 N, 1004 N		



kom	bež	855
PVC ugao RAM 1002 A, 1002 D, 1002 C, 1003 N, 1002 N, 1004 N		



kom	srebro	856
Metalni ugao RAM 1001		



kom	srebro	5090
Metalni ugao RAM 1007		



kom	srebro	220
Metalni ugao za ram: RAM 1005 A		



kom	srebro	224
Prihvatačnik za amortizere RAM 1005 A		

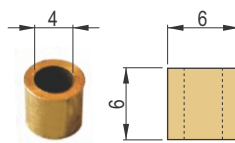

kom	srebro	1542
Metalna čaura - distancer za ručicu		



kom	providna	2346
PVC ispunja - T klin RAM 1002 N		

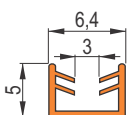

kom	providna	4790
PVC ispunja - četiri pera		

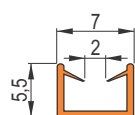

3	bela	4965
PVC ispunja - dva pera		

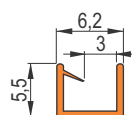

kom	bela	2370
PVC ispunja - jedno pero		

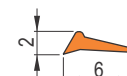

kom	providna	1902
PVC keder		



kom	nikl	5095	ravna
kom	nikl	5984	ravna sa usporivačem
kom	nikl	5096	polukoleno
kom	nikl	5097	koleno
Ukopavajuća šarka za RAM 1007			

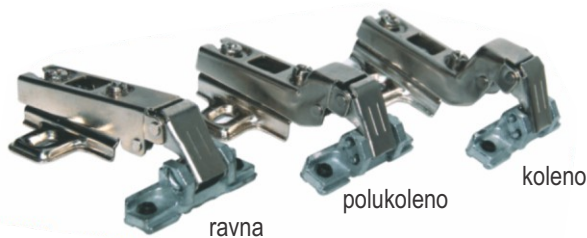

kom	nikl	231	ravna
kom	nikl	857	polukoleno
kom	nikl	858	koleno
Ukopavajuća šarka za RAM 1005 A			

Bušenje rupa za metalne uglove

(AL RAM 1002 A, 1002 D, 1002 C, 1001, 1002 N, 1003 N)

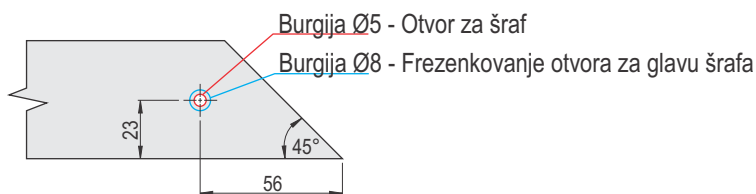

Napomena: Obratite pažnju na freziranje otvora!

Burgija mora biti dobro naoštrena, što omogućava da glava šrafa lepo nalegne u freziranu rupu. U suprotnom, ako freziranu rupu nije svuda isti, postoji mogućnost da se na aluminijumskim ramovima prilikom stezanja uglova, pojave otvori na gerovanim spojevima.

Kako bi ste izbegli da upadnete u ovaj problem, mi Vam nudimo uslugu sečenja, gerovanja i sklapanja Al ramova, naravno sa garancijom da će svi spojevi, kao i kompletna izrada biti besprekorni.

Montaža metalne čaure - Distancer ručice:

Čaura se koristi kao distancer koji odvaja ručicu od stakla, a istovremeno štiti staklo od tela šrafa koji prolazi kroz aluminijumski ram i staklo. Metalna čaura viri iz stakla 1,5mm.

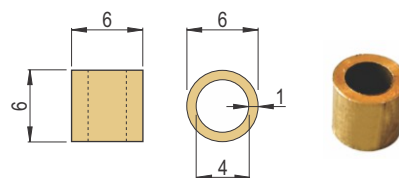

- 1 Al ram profil
- 2 Staklo
- 3 Čaura - Distancer
- 4 PVC podloška
- 5 Šraf M4
- 6 Ručica

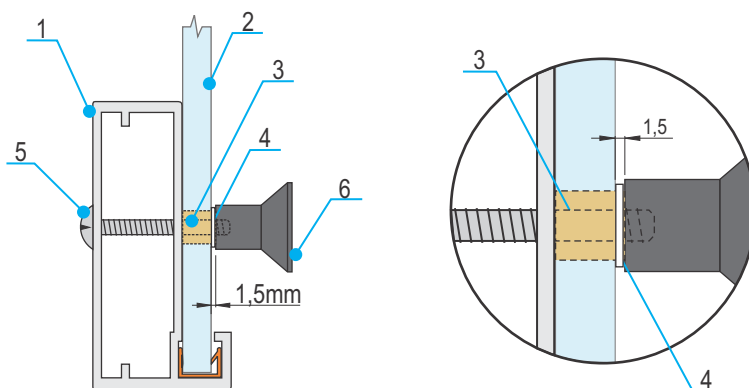

RAM 1007 - Ukopavanje Al profila za montažu šarki

- 1 Otvor za šarku (glodalo)

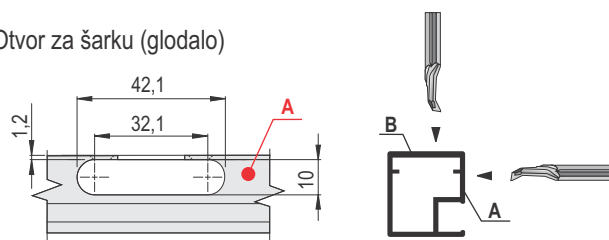

- 2 Rupe za vijke (burgija)

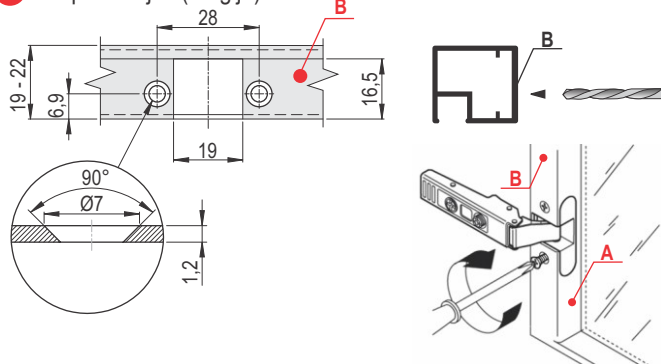

RAM 1007 - Bušenje rupa za metalni ugao

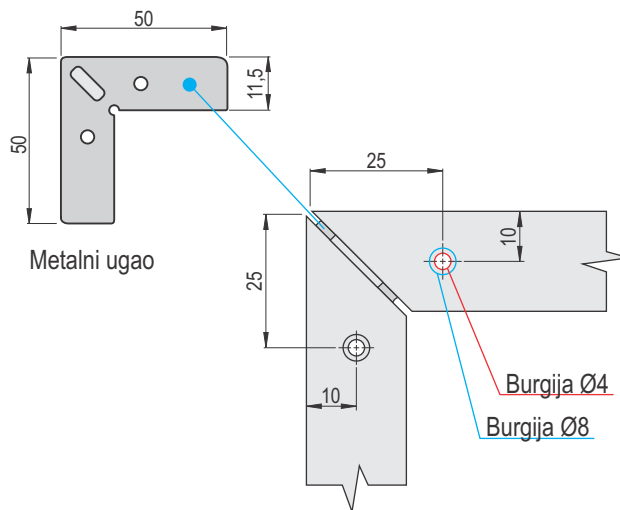

* Potrebno je upustiti (frezirati) rupu za šraf, da bi glava šrafa bila u ravni sa profilom.

PROFILI ZA IZRADU ZIDNIH PANELA

Aluminijumski profili za izradu zidnih panela od stakla i drugih pločastih materijala.

Al profili za izradu zidnih panela predviđeni su za ispunu debljine 8mm. Ako postavljate pločasti materijal debljine 6mm, PVC odbojnici su obavezni. Vrsta ispunе: Pamplex staklo, kaljeno staklo, klirit ili bilo koja ispunа od 6mm do 8mm debljine. Svi aluminijumski profili eloksrani su u srebrno mat eloksažu.



		šifra
6	mat srebrno	4104
EP - 1067		
Jedinica mere: metar		

Al gornji profil
(1,5m; 2m; 3m; 4m i 6m)



		šifra
6	mat srebrno	4121
EP - 1068		
Jedinica mere: metar		

Al poklopac gornjeg profila
(1,5m; 2m; 3m; 4m i 6m)



		šifra
6	mat srebrno	4110
EP - 1066		
Jedinica mere: metar		

Al donji profil
(1,5m; 2m; 3m; 4m i 6m)



		šifra
3	mat srebrno	4102
EP - 1065		
Jedinica mere: metar		

Al bočni profil
(1,5m i 3m)

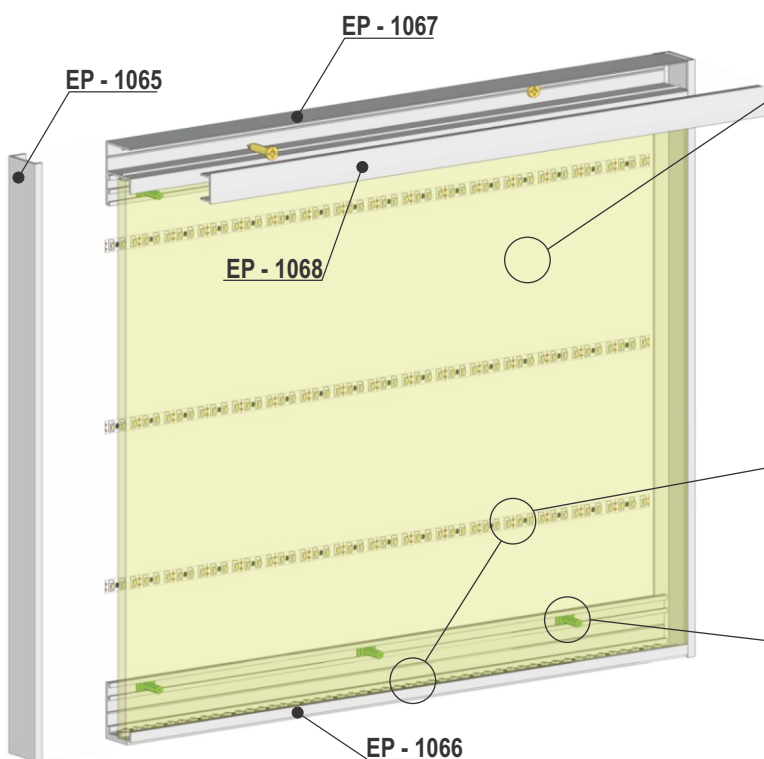
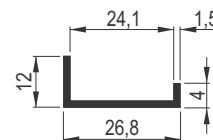
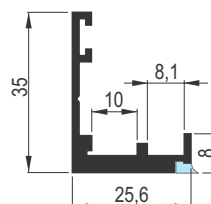
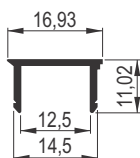
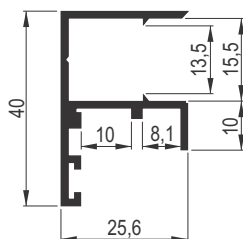

Vrsta ispunе:

- Pamplex staklo, kaljeno staklo, klirit...
- Bilo koja ispunа debljine 6mm do 8mm



Mogućnost postavljanja LED dioda na zid iza stakla, ili u prostor predviđen za diode unutar Al profila.



PVC odbojnik se uvlači u kanale gornjeg i donjeg profila, a služi da privuče ispunu napred uz profil i ne dozvoli eventualno pomeranje. Seče se ručno na potrebnu dimenziju. **Na ovaj način moguće je koristiti ispunе debljine 6mm.**

Izračunavanje dimenzije ispune

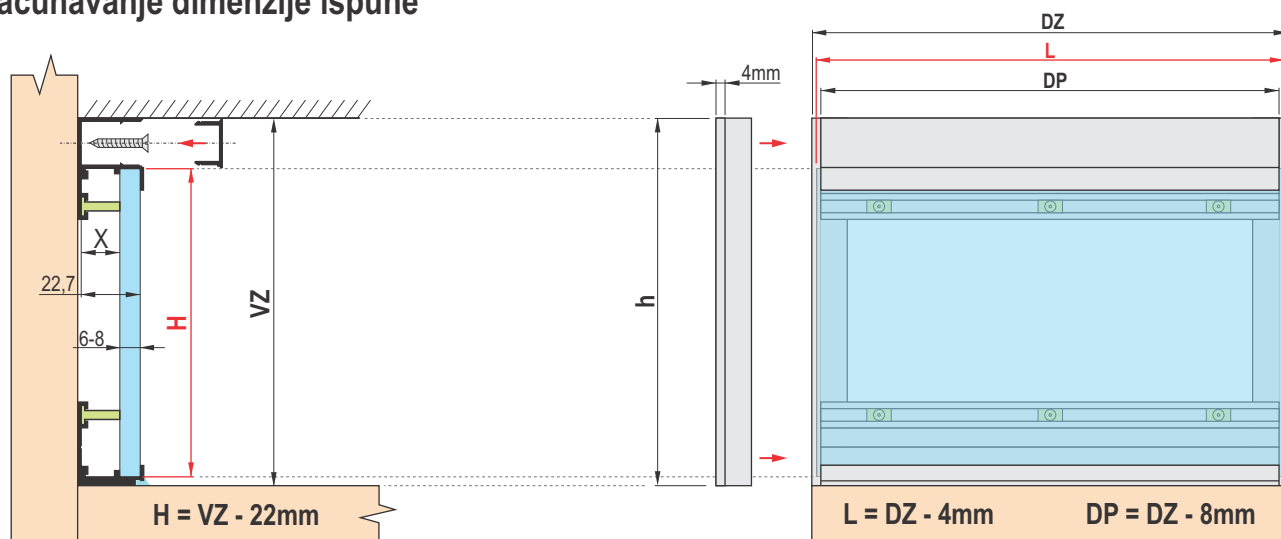

H - Visina stakla

VZ - Visina zida

X - Dužina PVC odbojnika

h - Visina bočnog profila ($h = VZ - 1mm$)

L - Dužina stakla

DZ - Dužina zida

DP - Dužina profila

(EP - 1067 - 1068 - 1066) skraćujete za 8mm, samo u slučaju da postavljate bočni profil.

Uputstvo za montažu

- 1 Bočni profil se poručuje po potrebi u dužinama od 1,5m i 3m. Visinu bočnog profila potrebno je skratiti za jedan milimetar od visine zida.

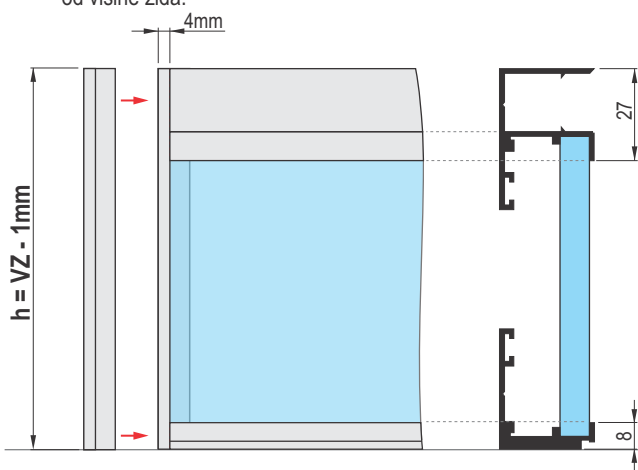

- 2 Kada u gornji i donji profil ubacite odgovarajući broj PVC odbojnika, sklopite konstrukciju sa ispunom (staklo, klirit...). Uspravite panel u paralelnu ravan sa zidom. PVC odbojnici se postavljaju ako je staklo debljine 6mm.

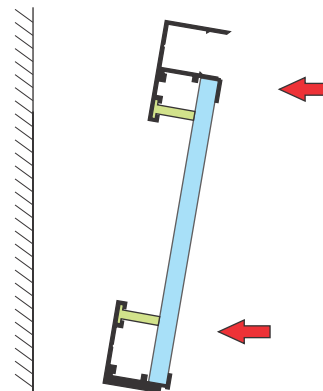

- 3 Ubacite bočne profile i panel pristonite do zida.

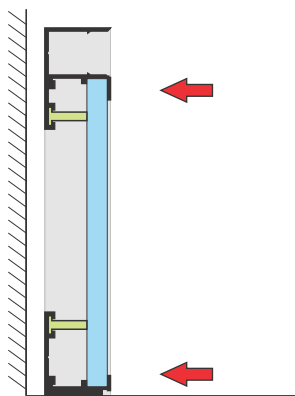

- 4 Gornji profil obavezno utiplotati, a šrafove pokrite maskom gornjeg profila.

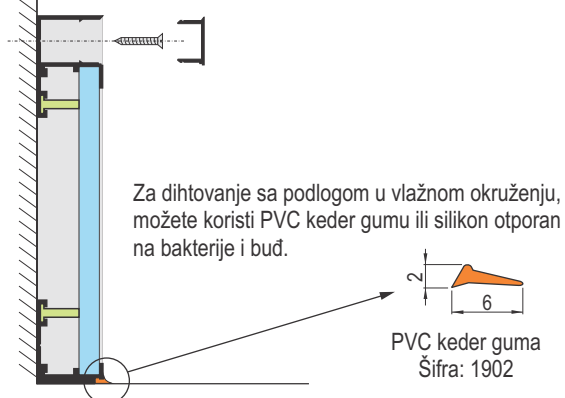

TAB PROFILI ZA IZRADU TABLI

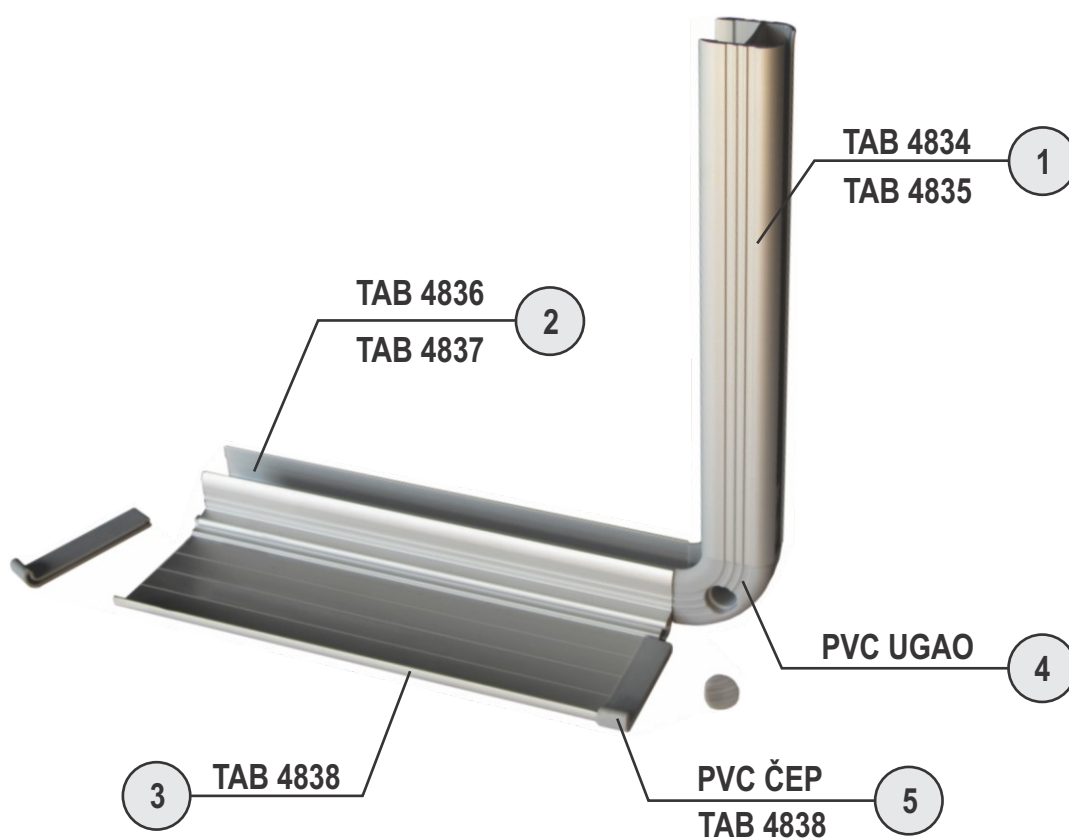

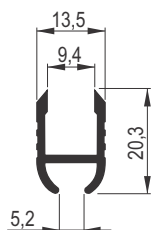

TAB 4834
Al gornji i bočni
ram profil

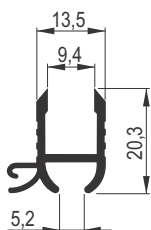

TAB 4836
Al donji
ram profil

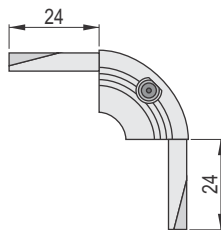

**PVC ugao za
TAB 4834 - 4836**
ram profile

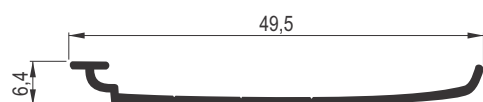

TAB 4838
(Držač za sundefere, krede, markere...)

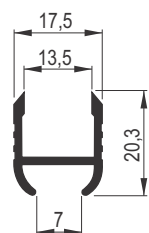

TAB 4835
Al gornji i bočni
ram profil

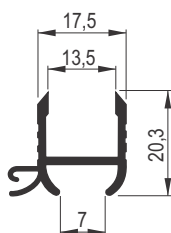

TAB 4837
Al donji
ram profil

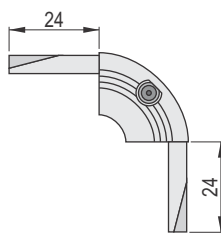

**PVC ugao za
TAB 4835 - 4837**
ram profile

**PROFILI ZA IZRADU TABLI
TAB - 13,5mm (uži)**



6	mat srebro	2020	TAB 4834
6	mat srebro	2347	TAB 4836
6	mat srebro	2023	TAB 4838
kom	siva	2030	PVC ugao
set	siva	2348	PVC čep

Jedinica mere: metar / komad / set

**PROFILI ZA IZRADU TABLI
TAB - 17,5mm (širi)**



6	mat srebro	2021	TAB 4835
6	mat srebro	2022	TAB 4837
6	mat srebro	2023	TAB 4838
kom	siva	2031	PVC ugao
set	siva	2348	PVC čep

Jedinica mere: metar / komad / set

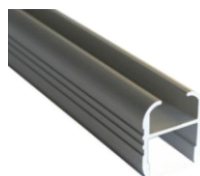

TAB 4834 - 4835

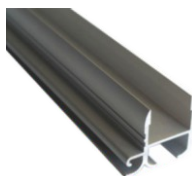

TAB 4836 - 4837



PVC ugao



PVC čep

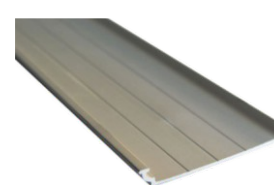

TAB 4838

AL PROFILI I ELEMENTI ZA IZRADU REKLAMA

- REK OBOSTRANA „ A ” REKLAMA
- REK OBOSTRANA STUB REKLAMA
- REK JEDNOSTRANA INFO STUB REKLAMA
- REK PROFIL ZA OBELEŽAVANJE
- REK ZIDNA INFO REKLAMA



europrofil

REK OBOSTRANA „A” REKLAMA

U ponudi imamo gotove „A” reklame, za postere dimenzija: B1 (707mm x 1000mm) i B2 (500mm x 707mm).
Gotov aluminijumski A stalak je 153cm visine.

Ram plakata je od eloksiranih aluminijumskih profila izrađenih upravo za potrebe reklama različitih dimenzija. Nogice „A” stalka takođe su od eloksiranog aluminijuma (Al profil 25 x 25mm). Zaštita plakata - postera je u vidu antirefleks providne folije. Leđa rama se rade od Akyplac polipropilen tabli. Na krajevima nogica postavljeni su PVC čepovi koji obezbeđuju podne obloge od grebanja.

Zamena plakata - postera vrši se na lak način, brzim klik - klak pokretom na samom ramu (REK 7454 - 7453 ili REK 1067).

„A” reklama je najčešći oblik stalka za plakate koje vidamo kako napolju na šetalištima, tako i u unutrašnjim prostorima.

Napomena: Obostrana „A” reklama sa leđima od Akyplac polipropilen tabli predviđena je samo za unutrašnju upotrebu, dok se za spoljašnju upotrebu preporučuje obostrana „A” reklama sa leđima od lima.

Na sledećoj strani, pogledajte sve Al profile i elemente koji su potrebni za izradu dvostrane „A” reklame na meru.

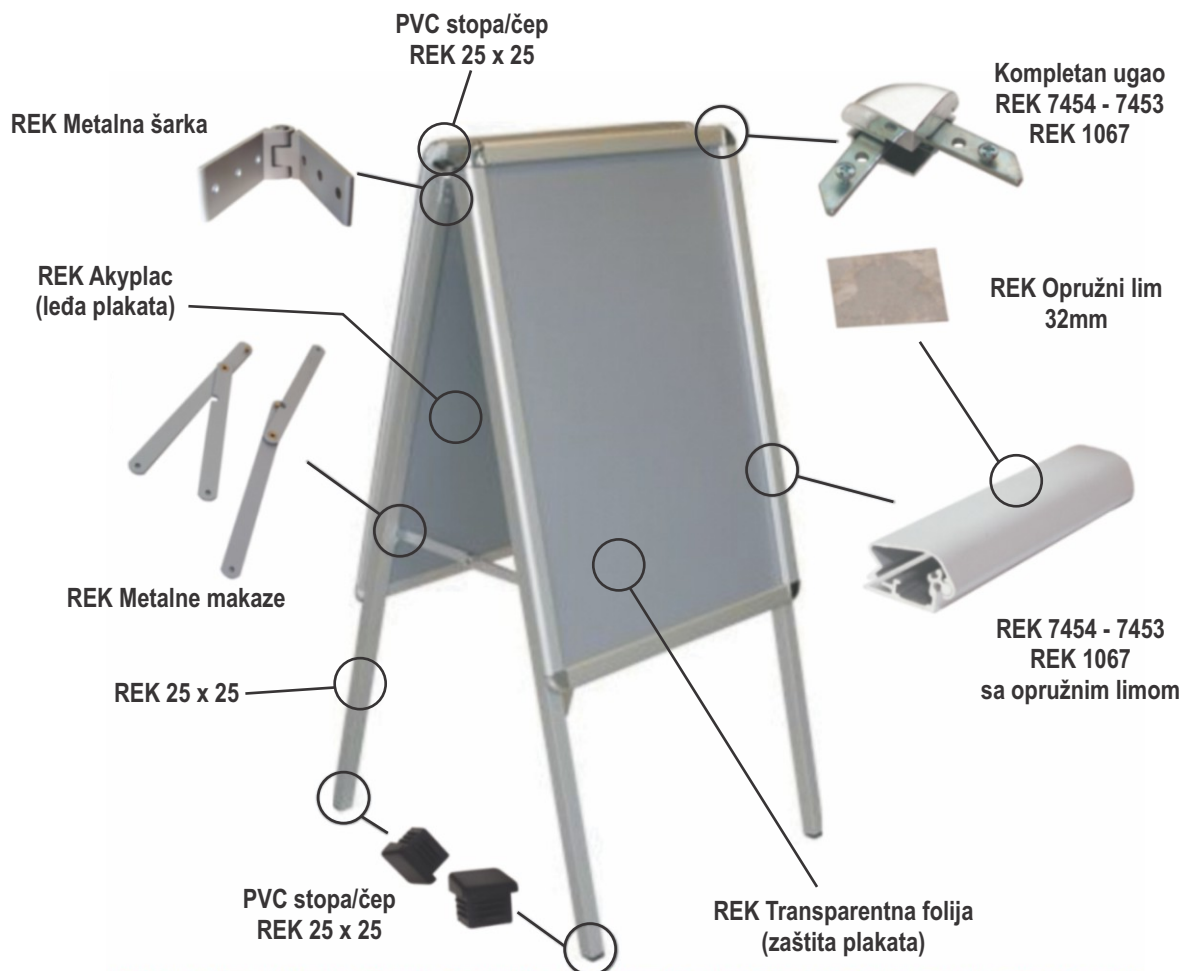

		šifra		
kom	mat srebro	2843	Format B1	
Gotova „A” reklama				
Jedinica mere: komad				

		šifra		
kom	providna	2844	Format B2	
Gotova „A” reklama				
Jedinica mere: komad				

REK OBOSTRANA „A” REKLAMA - ELEMENTI

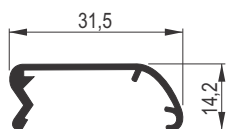

6	mat srebro	458	REK 7454 gornji
Jedinica mere: metar			



6	mat srebro	457	REK 7453 donji
Jedinica mere: metar			



kom	sjaj srebro	1892*	REK - Ugao 7454 / 7453
Jedinica mere: komad			

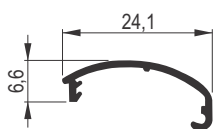

6	mat srebro	4628	REK 1067 gornji
Jedinica mere: metar			

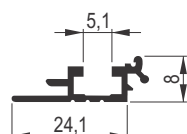

6	mat srebro	4629	REK 1067 donji
Jedinica mere: metar			



kom	sjaj srebro	5193	REK 1067 Ugao
Jedinica mere: komad			

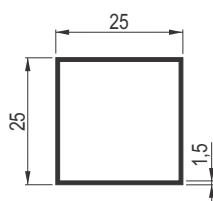

6	mat srebro	910	REK 25 x 25
Jedinica mere: metar			



kom	crna	6211	stopa / čep - konus REK 25 x 25
kom	crna	902	stopa / čep - ravna REK 25 x 25
Jedinica mere: komad			



par	mat srebro	901	REK Šarka
Jedinica mere: komad			



par	mat srebro	900	REK Makaze
Jedinica mere: komad			



kom	mat srebro	1022	REK 7454 / 7453 - Lim
Jedinica mere: komad			

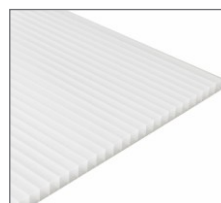

m ²	bela	2839	REK Akyploc
Jedinica mere: m ²			



m ²	provodna	2477	REK transp. folija
Jedinica mere: m ²			

REK OBOSTRANA STUB REKLAMA

Aluminijumski profili i elementi za izradu obostrane stub reklame.

Sam ram plakata je od eloksiranih aluminijumskih profila izrađenih upravo za potrebe reklama različitih dimenzija.

Zamena plakata - postera vrši se na lak način, brzim klik - klak pokretom na samom ramu (REK 7454 - 7453 ili REK 1067). Zaštita plakata je u vidu antirefleks providne folije. Leđa Al rama su od bele Akyplac polipropilen ploče. Noge, tj. konstrukcija obostrane reklame je takođe od eloksiranog aluminijuma (REK 1059 D). Na kraju svake nogice-postolja predviđeno je da se postave PVC čepovi.

Prilikom izrade svetleće dvostrane reklame, između dva klik - klak rama ubacuje se konstrukcija od Al profila 25 x 25mm za koje se kači osvetljenje (neonska ili LED rasveta).

Na sledećoj strani, pogledajte sve Al profile i elemente koji su potrebni za izradu dvostrane reklame na meru.

Kompletan ugao
REK 7454 - 7453
REK 1067

REK 7454 - 7453
REK 1067
sa opružnim limom

REK 1059 D

PVC čep za profil
REK 1059 D



REK OBOSTRANA REKLAMA - ELEMENTI

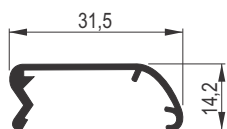

6	mat srebro	458	REK 7454 gornji
Jedinica mere: metar			



6	mat srebro	457	REK 7453 donji
Jedinica mere: metar			

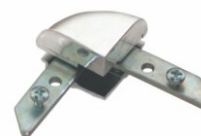

kom	sjaj srebro	1892*	REK - Ugao 7454 / 7453
Jedinica mere: komad			

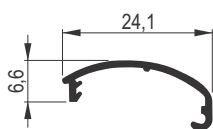

6	mat srebro	4628	REK 1067 gornji
Jedinica mere: metar			

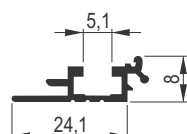

6	mat srebro	4629	REK 1067 donji
Jedinica mere: metar			



kom	sjaj srebro	5193	REK 1067 Ugao
Jedinica mere: komad			

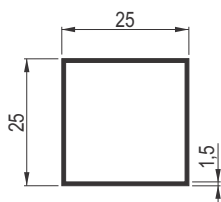

6	mat srebro	910	REK 25 x 25
Jedinica mere: metar			

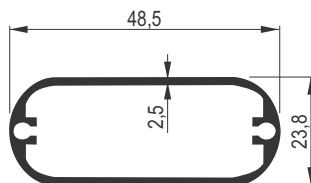

6	mat srebro	652	REK 1059
Jedinica mere: metar			



kom	sjaj srebro	908	PVC ugao REK 1059
Jedinica mere: metar			



kom	siva	907	REK 1059 D - PVC cep
Jedinica mere: komad			



kom	mat srebro	1022	REK 7454 / 7453 - Lim
Jedinica mere: komad			



m ²	bela	2839	REK Akyplac
Jedinica mere: m ²			



m ²	providna	2477	REK transp. folija
Jedinica mere: m ²			

REK JEDNOSTRANA INFO STUB REKLAMA

U ponudi imamo gotovu info stub reklamu, formata A4 (210mm x 297mm).

Sam ram je od eloksiranih aluminijumskih profila, izrađenih upravo za potrebe reklama različitih dimenzija.

Zamena plakata - postera vrši se na lak način, brzim klik - klak pokretom na samom ramu (REK 7454 - 7453 ili REK 1067). Zaštita plakata je u vidu providne antirefleks folije. Pozadina rama je od alubond lima debljine 3 - 4 mm koji se nituje za Al stub. Stub info stalka je takođe od eloksiranog aluminijuma (REK 1059 D). Stopa info stub reklame je od čelika dimenzije 250 x 250 x 10mm, koja je plastificirana u boju aluminijuma.

Info stalke najčešće možemo videti u auto salonima, na sajamskim izložbama gde se opisuju izloženi proizvodi, na ulazima u restorane gde su istaknuti kulinarski specijaliteti i sl...

Na sledećoj strani, pogledajte sve Al profile i elemente koji su potrebni za izradu jednostrane info stub reklame.



kom	mat srebro	4223	Format A4
Gotova Info reklama			
Jedinica mere: komad			

REK JEDNOSTRANA INFO STUB REKLAMA - ELEMENTI

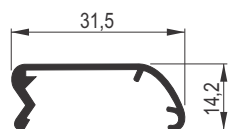

6	mat srebro	458	REK 7454
Jedinica mere: metar			gornji



6	mat srebro	457	REK 7453
Jedinica mere: metar			donji



kom	sjaj srebro	1892*	REK - Ugao
Jedinica mere: komad			7454 / 7453

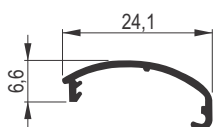

6	mat srebro	4628	REK 1067
Jedinica mere: metar			gornji

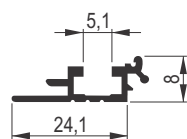

6	mat srebro	4629	REK 1067
Jedinica mere: metar			donji



kom	sjaj srebro	5193	REK 1067
Jedinica mere: komad			Ugao

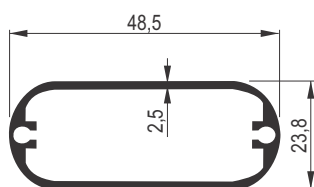

6	mat srebro	652	REK 1059
Jedinica mere: metar			



kom	siva	907	PVC čep
Jedinica mere: komad			1059 D



kom	mat srebro	1022	Lim
Jedinica mere: komad			7454 / 7453

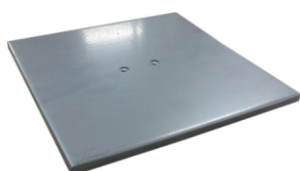

kom	siva plastifik.	6955	Info stub
Jedinica mere: komad			stopa



m ²	providna	2477	providna
Jedinica mere: m ²			folija

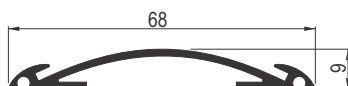
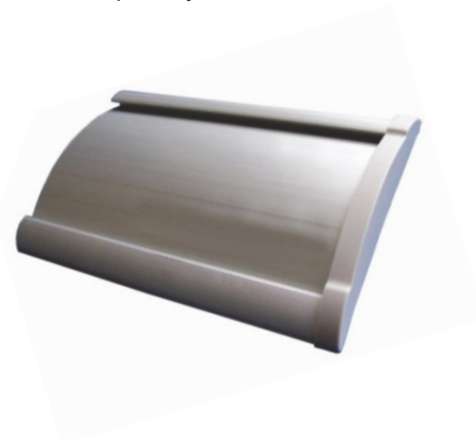

REK PROFIL ZA OBELEŽAVANJE

Aluminijumski profil REK 3532 za obeležavanje prostorija, vrata, kancelarija i sl...
Al profil REK 3532 eloksiran je u srebro mat eloksažu i prodaje se na metar.
Dužina Al profila je 3m.



		šifra	
3	mat srebro	3135	REK 3532
Jedinica mere: metar			



		šifra	
kom	siva	3136	PVC čep REK 3532
Jedinica mere: komad			

REK ZIDNA INFO REKLAMA

Aluminijumski profili za izradu zidnih Info tabli.

Svi aluminijumski profili koji se koriste pri izradi zidnih Info tabli su eloksirani. U ponudi imam nekoliko modela profila za izradu zidnih Info tabli:

1. Al klik - klak profili za izradu rama za zidne Info table (REK 7454 - 7453 i REK 1067) sa PVC uglovima.
2. Al „ U ” profili KP 1028, dimenzija 6mm i 8mm za koje ne postoje uglovi, već se izgerovani profili spajaju lepljenjem.

Na sledećoj strani, pogledajte sve Al profile i elemente koji su potrebni za izradu zidnih Info tabli.



Kompletan ugao
- REK 7454 - 7453
- REK 1067



Al klik-klak profil
- REK 7454 - 7453
- REK 1067 gornji / donji
sa opružnim limom



KP 1028 / 10
KP 1028 / 6

ZIDNA INFO REKLAMA - ELEMENTI

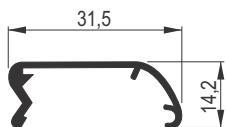

6	mat srebro	458	REK 7454 gornji
Jedinica mere: metar			



6	mat srebro	457	REK 7453 donji
Jedinica mere: metar			



kom	sjaj srebro	1892*	REK Ugao 7454 / 7453
Jedinica mere: komad			

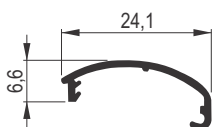

6	mat srebro	4628	REK 1067 gornji
Jedinica mere: metar			

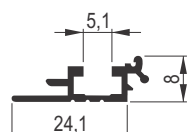

6	mat srebro	4629	REK 1067 donji
Jedinica mere: metar			



kom	sjaj srebro	5193	REK 1067 Ugao
Jedinica mere: komad			



kom	mat srebro	1022	Lim 7454 / 7453
Jedinica mere: komad			

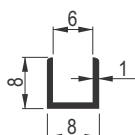

3	mat srebro	4093	KP 1028 / 6
Jedinica mere: metar			

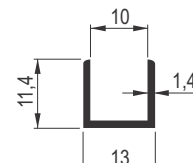

3	mat srebro	637	KP 1028 / 10
Jedinica mere: metar			



m ²	bela	2839	REK Akyplac
Jedinica mere: m ²			



m ²	providna	2477	REK transp. folija
Jedinica mere: m ²			

AL PROTIVKLIZNE I PERFORIRANE TABLE

- AL GLATKA TABLA - 2m²
- AL PROTIVKLIZNA REBRATA TABLA - 2m²
- AL PERFORIRANA TABLA - ELIPSA - 2m²
- AL PERFORIRANA TABLA - KVADRAT - 2m²

europrofill



AL GLATKA TABLA

1000 x 1 x 2000mm

Aluminijumska tabla svoju primenu pronalazi u izradi nameštaja od pločastih materijala, kao i u završnim radovima u građevinarstvu. Aluminijumske table najčešće možemo videti u javnim prostorima. Koriste se kao maske, paneli za oblaganje u eksterijeru i enterijeru, paneli za ispunu ograda i drugih površina, stepenicama, pultovima, zidovima...

Aluminijumska tabla 1000 x 1 x 2000mm prodaje se kao cela tabla (2m²).

Debljina Al table je 1mm.

		šifra
2m ²	mat srebro	962
Jedinica mere: m ²		

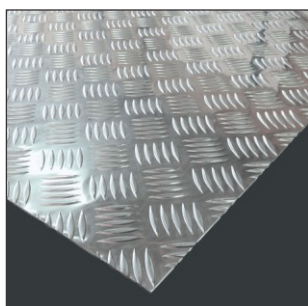
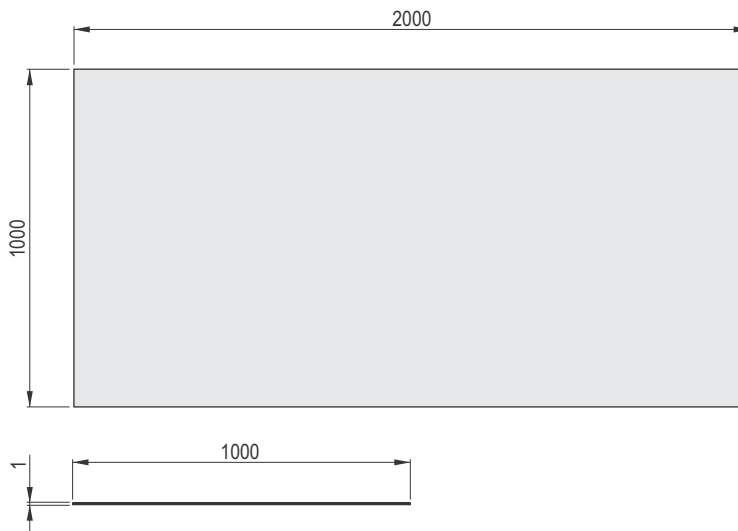
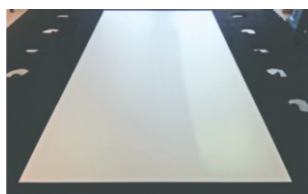

AL PROTIVKLIZNA REBRATA TABLA

1000 x 3 x 2000mm

Aluminijumska protivklizna tabla svoju primenu pronalazi u izradi nameštaja od pločastih materijala, kao i u završnim radovima u građevinarstvu. Aluminijumske protivklizne table koriste se u javnim prostorima, na ulazima u autobuse, na stepenicama, zidovima, koriste se kao maske, paneli za oblaganje u eksterijeru i enterijeru, paneli za ispune ograda i drugih površina.

Aluminijumska protivklizna rebrasta tabla 1000 x 3 x 2000mm prodaje se kao cela tabla (2m²).

Debljina Al protivklizne table je 1,8mm u osnovi, a na izbočenim (rebrastim) delovima debljina table je 2,9mm.

		šifra
2m ²	mat srebro	3629
Jedinica mere: m ²		

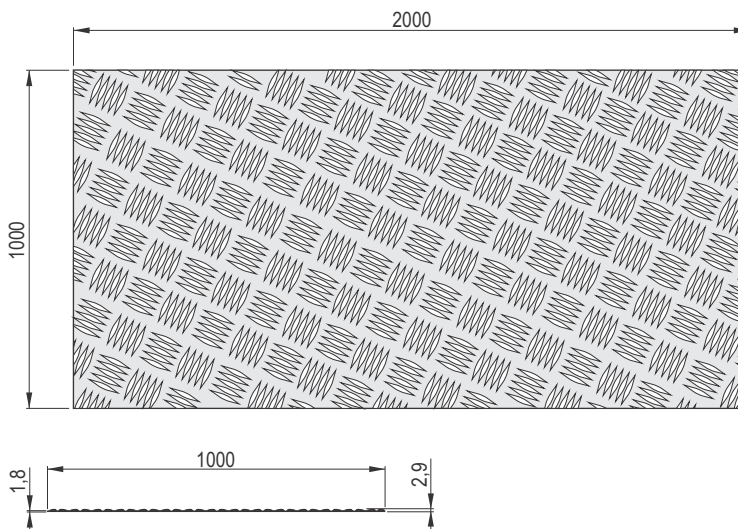

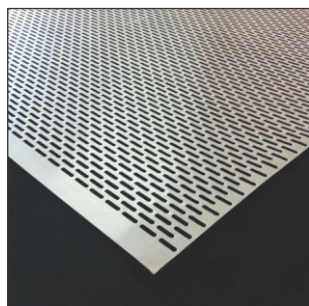

AL PERFORIRANA TABLA - ELIPSA

1000 x 1 x 2000mm

Aluminijumska perforirana tabla svoju primenu pronalazi u izradi nameštaja od pločastih materijala, kao i u završnim radovima u građevinarstvu. Aluminijumske perforirane table koriste se kod pokrivanja velikih ventilacionih otvora, mogu se koristiti i kao dekorativni detalj u izradi nameštaja, npr. kada je potrebno zatvoriti otvor ispod stola, itd...

Aluminijumska perforirana tabla 1000 x 1 x 2000mm prodaje se kao cela tabla. Debljina perforirane table je 1mm.

		šifra
2m ²	mat srebro	963
Jedinica mere: m ²		

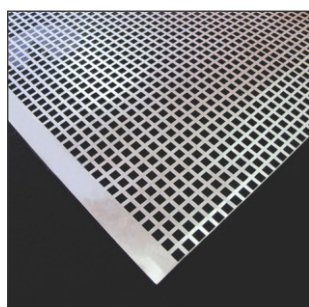
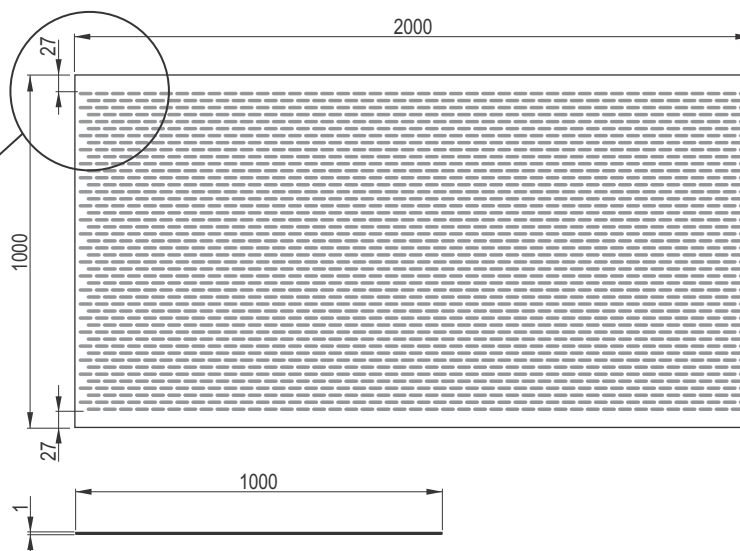
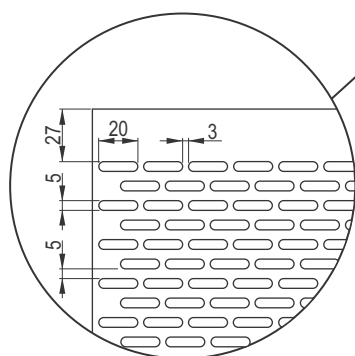

AL PERFORIRANA TABLA - KVADRAT

1000 x 1 x 2000mm

Aluminijumska perforirana tabla svoju primenu pronalazi u izradi nameštaja od pločastih materijala, kao i u završnim radovima u građevinarstvu. Aluminijumske perforirane table koriste se kod pokrivanja velikih ventilacionih otvora, kao dekorativni detalj u izradi nameštaja, npr. kada je potrebno zatvoriti otvor ispod stola, itd...

Aluminijumska perforirana tabla dimenzija 1000 x 1 x 2000mm prodaje se kao cela tabla. Debljina perforirane table je 1mm.

		šifra
2m ²	mat srebro	4426
Jedinica mere: m ²		

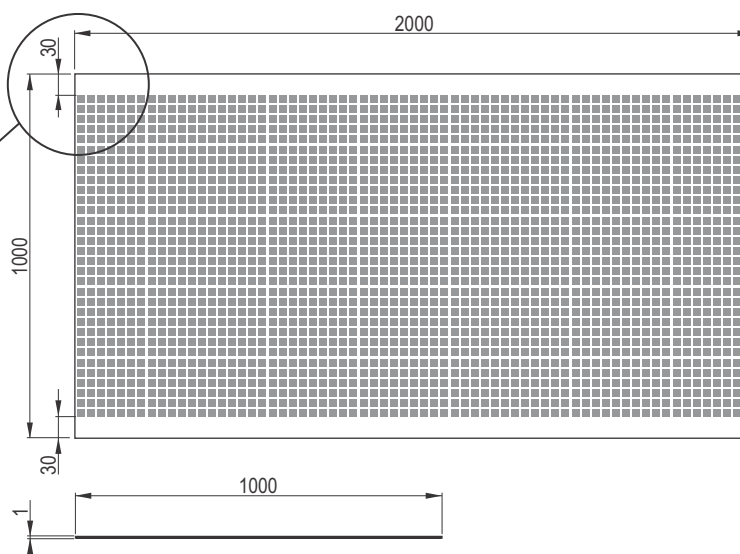
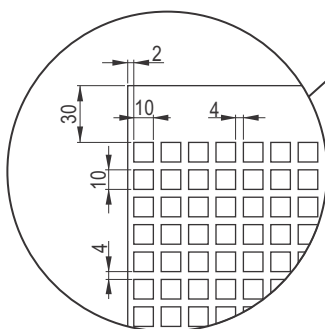

euro***profil***

VELEPRODAJA:

Obrenovački put bb (Makiš - Komgrap), 11000 Beograd

Tel / fax. +381 113558950

Tel. +381 113572925

Tel. +381 113572889

Mob. +381 646458343

E - mail: office@europrofil.rs, euprof@eunet.rs

Radno vreme:

radnim danima: od 08:30h do 16:30h,

subotom: od 09:00h do 15:00h.

MALOPRODAJA 1:

Trgovačka 83 (Žarkovo), 11000 Beograd

Tel / fax. +381 112500506

Tel. +381 112506753

Mob. +381 646458341

E - mail: maloprodaja@europrofil.rs

Radno vreme:

radnim danima: od 08:00h do 20:00h,

subotom: od 09:00h do 15:00h.

MALOPRODAJA 2:

Batajnički drum 1 (Galenika), T.C. BN BOS, 11080 Zemun

Tel / fax. +381 113715381

Mob. +381 646406603

E - mail: maloprodaja2@europrofil.rs

Radno vreme:

ponedeljak - subota: od 09:00h do 21:00h,

nedelja: od 09:00 do 16:00h.

www.europrofil.rs